

14. INSTALLATION TEMPLATE

Ratio 1:1

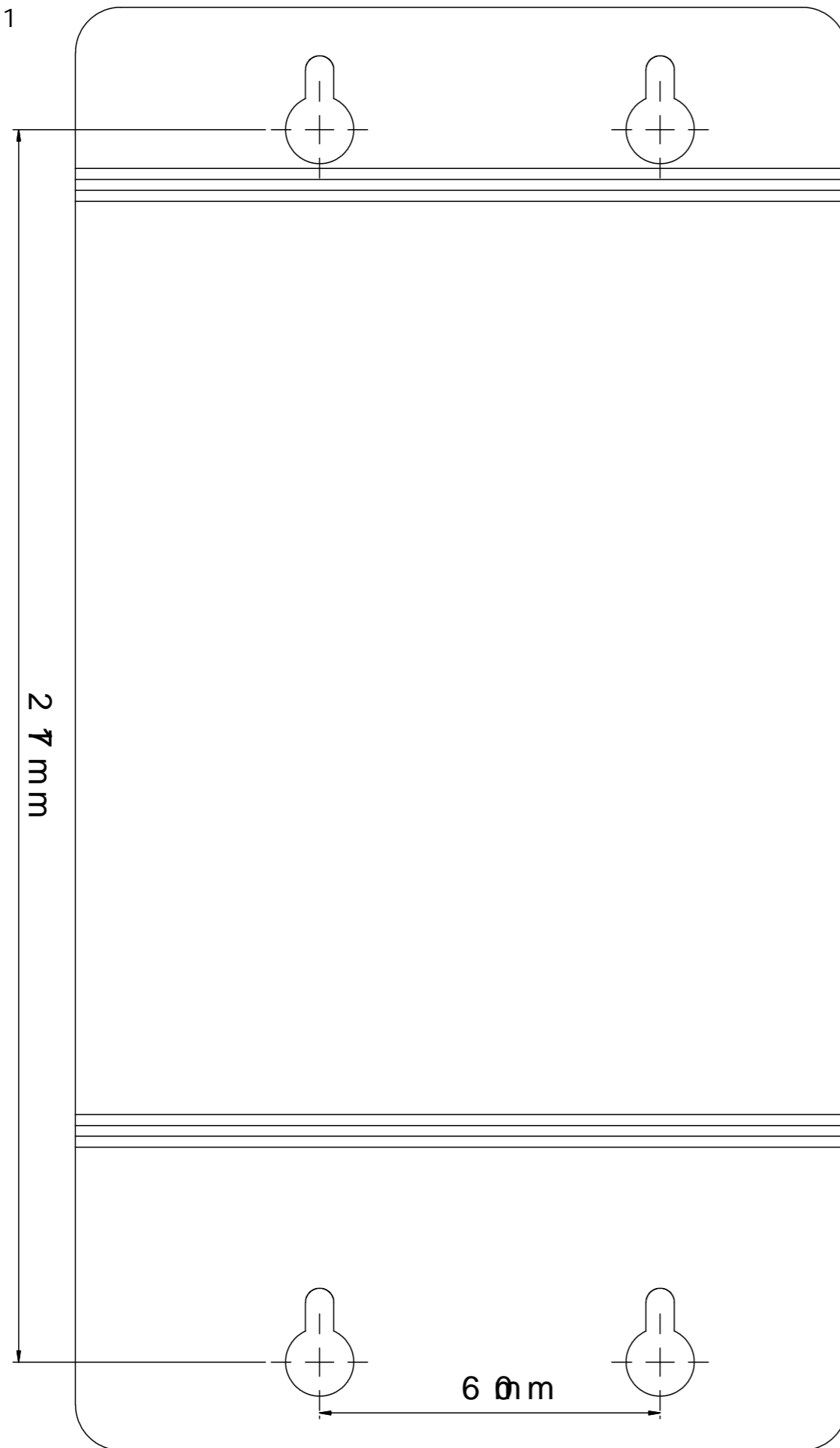

SSC_{mini}[®]

SALT CHLORINATOR

USER MANUAL

1. SAFETY WARNING AND RECOMMENDATIONS

The equipment should be assembled and handled by truly qualified people.

Current electrical and accident prevention regulations should be followed.

Under no circumstances will the manufacturer be held responsible for the assembly, installation or start-up, nor any handling or fitting of components unless they are carried out on its premises.

The working voltage of **SSCmini**[®] is 220-240V, 50/60Hz. Do not attempt to alter the system to operate at a different voltage.

Check all the electrical connectors to avoid false contacts and their consequent overheating.

Before installing and replacing any component, disconnect the control unit from the main power supply; only replacements provided by Emaux can be used for replacing.

The control unit must be installed in places with sufficient ventilation. The equipment should not be installed where working pressure exceeds 2.0 bar.

If the supply cord is damaged, it must be replaced by the manufacturer, its service agent or similarly qualified persons in order to avoid a hazard.

This appliance can not be used by children and persons with reduced physical, sensory or mental capabilities or lack of experience and knowledge. Children shall not play with the appliance.

Cleaning and user maintenance shall not be made by children without supervision.

2. SAFETY GUIDE

IMPORTANT: The instruction manual you are holding includes essential information on the safety measures to be implemented for installation and start-up. Therefore, the installer as well as the user must read the instructions before beginning installation and start-up.

Keep this manual for future reference.

When using this electrical equipment, basic safety measures listed below should be followed:

- Disconnect all AC power during installation.
- To reduce the risk of injury, do not permit children to use this product unless they are closely supervised.
- A green colored terminal marked "Earth Ground" is located inside the wiring compartment. To reduce the risk of electric shock, this terminal must be connected to the grounding means provided in the electric supply service panel with a continuous copper wire equivalent in size to the circuit conductors supplying the equipment.
- To reduce the risk of electric shock, connect the local common bonding grid in the area of the swimming pool or spa to these terminals with an insulated or bare copper conductor.

3. CONTENTS OF PACKAGE

Following components are contained in the package:

SSCmini[®] Control unit

SSCmini[®] Electrolytic Cell

1.5" and 2" Universal Unions

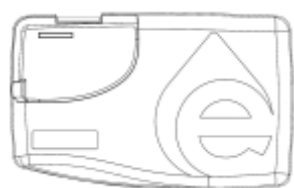

Standard working voltage	220-240 V AC – 50/60 Hz
Maximum chlorine production	20 g/h
Maximum Pool Volume	90 m ³
Water salinity required	3–4 g/l
Working Temperature of Water	10°C – 45°C (50°F – 113°F)
Electrodes	Titanium plates

Should a defect become evident during the term of warranty, Emaux will, at its option, repair or replace such item or part at its own cost and expense. Customer will need to follow the warranty claim procedures from Emaux in order to obtain the benefit on this warranty.

Emaux is not, however, responsible under this warranty for any cost of shipping or transportation of the equipment or parts thereof "to" or "from" our technical operations. Emaux is not liable for any loss of time, inconvenience, incidental expenses such as labor cost, phone calls, legal cost or material cost incurred in connection with the replacement or removal of the equipment, or any other consequential or incidental damage on persons or assets. Emaux will be not responsible for any business profit loss or operation stop due to the non-conformity product equipment. No indemnity or damages can be claimed on any account whatever.

12.4 WARRANTY OR REPRESENTATIONS BY OTHERS

No dealer or other person has authority to make any warranty or representation concerning Emaux or its products.

Accordingly, Emaux is not responsible for any such warranty or representation.

13. PART LIST

Item	Part No.	Part Name	QTY
1	530095108	Transparent Lid	1
2	530085108	Chlorinator Top Cover	1
	106855108	Switch keys	1
3	106255294	Control electronic board (230 /240V)	1
4	530145108	lower lid	1
5	106231416	Lock for Cable	1
	105021259	Cable and Euro Plug	1
	105005227	Cable	1
	105011249	Cable and Australia Plug	1
6	106485122	SP Power Point	1
7	106161403	Transformer for SSC25	1
8	106441496	25 Silicon contrlled combination	1
9	116095118	Cooling aluminum	1
10	530135108	Electrolytic cell nut	1
11	89380226	Five core cable with electronic board	1
12	89380227	Electrolyzer body	1
13	111040010	O -Ring	1
14	530045108	Electrolyzer housing	1
15	111202472	O -Ring	2
	430300943	1 .5" Union	2
16	430300989	2 .0" Union	2
	430170991	2 .0" Nut	2

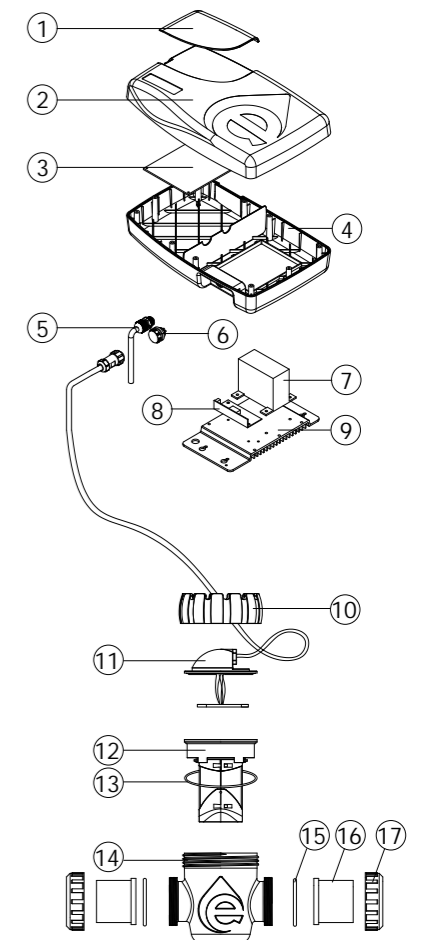

available through state of the art process. Emaux proudly warrants its products as follows:

EXTENDED WARRANTY FOR SPECIFIC PRODUCTS (OFFERED FROM DATE OF INVOICE)	
Product	Warranty Period
Filters & Filter Systems	2 years
Pumps	1 year
Underwater Lights	1 year (bulbs 90 days)
Ladders	1 year
Control devices	1 year
Heat Pumps & Heat Exchangers	1 year
Salt Chlorinators & UV Systems	1 year (2 years for cell material)
Pool Fittings	1 year
Cleaning Equipment & All others	1 year

12.1 EXCEPTIONS THAT MAY RESULT IN DENIAL OF A WARRANTY CLAIM

1. Damage caused by careless handling, improper repackaging or shipping.
2. Damage due to misapplication, misuse, abuse or failure to operate and install the equipment as specified in this manual.
3. Damage caused by a misuse, abuse or failure to operate and install the equipment out of the scope of a professional level demanded in similar equipment or installation type.
4. Damage due to unauthorized product modifications or failure to use Emaux original replacement parts.
5. Damage caused by negligence or failure to properly maintain products as specified in this manual.
6. Damage caused by failure to maintain water chemistry in conformity with the standards of the swimming pool industry for any length of time.
7. Damage caused by water freezing inside the product.
8. Accident damage, fire, natural disaster or other circumstances outside the control of Emaux.
9. Items repaired or altered in any way by any person that is not authorized by Emaux.
10. Wear & tear parts.

12.2 CLAIM PROCESS

Summary of Emaux Claim Process in 3 steps:

1. Claim: Customer contacts Emaux salesperson and provides complete details of the claim which includes:
 - a. Information about the failed product such as the part number(s) and serial number(s).
 - b. Description of the complaint/failure.
 - c. Pictures
2. Revision: Once the complaint is received, the product quality incident will then be reviewed by Emaux Quality Department following the "Emaux Warranty Policy".
3. Conclusion: After the investigation is completed, Emaux will inform the distributor accordingly.

12.3 WARRANTY OBLIGATION

Emaux warrants any of above items from workmanship and/or material(s).

4. INTRODUCTION

Emaux **SSCmini**[®] is an automatic chlorine generation system for pool sanitization and it is composed by two main components: an electrolytic cell and a control unit.

4.1 ELECTROLYTIC CELL

The electrolytic cell is composed by a number of titanium plates (electrodes) placed in a cell holder. The control unit regulates electrical current that passes through the titanium plates. One extreme of the plates will be anode and the other will be cathode.

Adding a certain concentration of salt in the water, this passes through the plates and thanks to the electrical current, the Hypochlorous acid is produced.

The following chemical reactions are produced in the plates of the electrolytic cell:

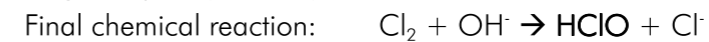
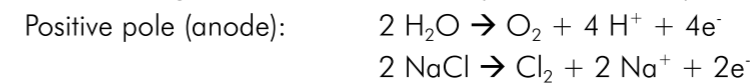

The operation requires a certain concentration of salt (4000 ppm), low enough that it normally will not be tasted. The **SSCmini**[®] automatically sanitizes your pool by converting the salt into Hypochlorous acid which kills bacteria and algae in the pool through a process called electrolysis.

Because chlorine will revert back to sodium chloride after killing the bacteria, the above reactions will continuously recycle virtually eliminating the need to add sanitizing chemicals to your pool. The only time you may need to add more salt to the pool is when water is replenished due to backwashing, draining, or splashing.

4.2 CONTROL UNIT

The control unit is provided with a microprocessor driven control system to regulate operation time inform about **SSCmini**[®] operation status and errors. The system also includes a self-cleaning procedure that avoids scale formation on the electrodes.

5. WATER CHEMISTRY

The following table shows the recommended levels of the chemical parameters required for a proper quality of water in the pool by using Emaux **SSCmini**[®].

Test your water periodically and ensure the levels are within the recommended range.

Salt Level	3000 - 4000 ppm
Free Chlorine	1.0 – 3.0 ppm
pH Value	7.2 – 7.6
Cyanuric Acid (stabilizer)	30 – 50 ppm
Total Alkalinity	80 – 120 ppm
Calcium Hardness	200 – 400 ppm
Metal	0 ppm

5.1 SALT LEVEL

The amount of salt required when using Emaux **SSCmini**[®] is between 3000 and 4000 ppm. To reach this concentration, it is necessary to 4 kg of salt per each cubic meter of pool water.

Low salinity (below 2500ppm) will cause premature cell failure. High salinity (above 6000ppm) will result in electro-oxidation and the corrosion of stainless steel swimming pool fixtures.

Salt required according to the pool volume:

Pool volume (m ³)	Salt (kg)	Pool volume (Gallon)	Salt (Pound)
10	40	2,642	88
20	80	5,283	176
30	120	7,925	264
40	160	10,567	352
50	200	13,209	440
60	240	15,850	528
70	280	18,492	616
80	320	21,134	704
90	360	23,775	792

Note: Table based on 4000 ppm of salt per m³ of water.

5.2 TYPE OF SALT

The most common salt used in swimming pools with Salt Electrolysis is Sodium Chlorine (NaCl) that is 99% pure. DO NOT use the following types of salts:

- rock salt;
- salt with more than 1% yellow prussiate of soda;
- Salt with more than 1% of anti-caking additives;
- Iodized salt.

5.3 ADDING AND REMOVING SALT

Before adding the salt into the pool, turn your filtration pump on and set your filtration valve manifold in position "Filtration". Add the salt directly into the pool or balance tank and do not allow the salt to sit in a pile on the bottom of the pool. Keep the filtration system running for 24 hours using a main drain or a vacuum suction nozzle as a main suction line.

The only way to remove the salt in the pool water is to partially drain the pool and refill with fresh water.

11. TROUBLESHOOTING

SSCmini[®] salt chlorinator informs the user about operation status and alerts about any problems that may have occurred. Apart from "Cell life low" and "No flow" indicators, a combination of "Alarm" and one of "Work schedule" LEDs (from 1 to 10) will illuminate to inform about a fault type.

	INDICATOR	POSSIBLE PROBLEM	SOLUTION
	CELL LIFE LOW	Cell life ended	Cell electrodes (titanium plates) have to be replaced as soon as possible.
	NO FLOW	Inadequate Water Flow (only if stand-by mode is not active)	Ensure that water flow rate of your filtration system is enough to fill the cell completely. Check if filtration pump is working properly, that there are no obstructions in the pool plumbing or pump prefilter. Filter backwashing might be necessary.
Work schedule LED	LED 1 / 2 CELL FAULT	Scale formation Incorrect water salinity Inadequate Water Flow	Clean the electrolytic cell (see Chapter 10). Test water salinity and adjust it (see Chapter 6.3). Ensure that water flow rate of your filtration system is enough to fill the cell completely. Check if filtration pump is working properly, that there are no obstructions in the pool plumbing or pump prefilter.
	LED 3	Incorrect power supply	Disconnect the unit from power supply for two minutes and then connect it again. Ensure that SSCmini [®] is receiving 220V-240VAC 50/60H input.
	LED 4	Water temperature out of working range	Test water temperature. If it is lower than 10°C, use your heating system to reach proper temperature; if it is higher than 45°C, turn off your heating system or use other methods to cool the water.
	LED 5 / 6	Low salinity and / or High temperature	Test water salinity and adjust it (see Chapter 6.3) Test water temperature. If it is higher than 45°C, turn off your heating system or use other methods to cool the water.
	LED 7 / 9	Unknown	Disconnect the unit from power supply for two minutes and then connect it again. If this error continues, contact technical service.
	LED 8 CELL FAULT	Scale formation Inadequate Water Flow Communication error between cell and control unit	Clean the electrolytic cell (see Chapter 10). Ensure that water flow rate of your filtration system is enough to fill the cell completely Check if filtration pump is working properly, that there are no obstructions in the pool plumbing or pump prefilter Make sure that the cell cap is properly plugged in and that the wire to the Control Box is not cut or damaged.
	LED 10	Communication error between cell and control unit	Make sure that the cell cap is properly plugged in and that the wire to the Control Box is not cut or damaged.

12. WARRANTY POLICY

Emaux manufactures its products with the highest standard of workmanship, using the best materials

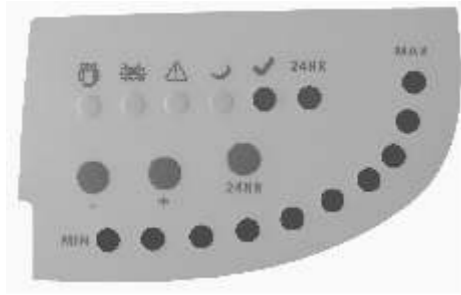

10:30 – next day 10:30

9. MAINTENANCE

Due to the Reverse Polarity system that avoids scale in the plates of the cell, the first action to consider for ensuring a long cell lifetime is to keep the chemical parameters always in the recommended range, especially the amount of salt, the pH and the water hardness.

1. Keep the salinity of the water always higher than 3000 ppm in order to avoid premature deterioration of the cell plates. The following formula determines the amount of salt to be added in the pool due to low salinity:

$$Q = (4-S) \times V$$

Where Q = quantity of salt (kg) to be added.

4 = correct salt concentration (constant).

S = Measured salt content in the pool

V = Volume of the pool in m3.

2. Keep the pH between 7.2 and 7.6. Check and clean the cell plates if the system has been working for a prolonged period with a pH value over 7.6.

ELECTROLYTIC CELL CLEANING PROCEDURE

If scale has formed on the titanium plates, the first cleaning procedure is as follows:

1. Switch off the power supply of **SSCmini**® control unit and remove electrodes from the cell.
2. Once removed, look inside and inspect for scale formation on the plates and for any debris which has passed through the filter and caught on the plates.
3. Try to remove the scale using a plastic or wooden tool (do NOT use metal as this will scratch the coating off the plates).

If the scale still remains on the plates, proceed the cell cleaning with acid solution:

1. Dilute hydrochloric acid with water: one part of acid in 10 parts of water.
ATTENTION! Always add acid into the water, NEVER add water into the acid. This prevents splashing of the acid when the water hits it. Wear rubber gloves and appropriate eye protection.
2. Submerge the cell plates in the solution for no more than 10 minutes. Plates plastic housing can be submerged in the solution, but avoid any contact with the cell connections and wires.
3. Rinse the cell with a high pressure hose. If any deposits are still visible, repeat soaking and rinsing.
4. If scaling persists, replace the cell by a new one.

10. WINTERIZING

During a long non-working period, such as winter, the following procedure must be carried out:

- Switch off **SSCmini**® control unit and disconnect it from power supply.
- Drain all water from the electrolytic cell, as well as filtration pump, filter and piping.
- Clean the cell plates with fresh water and dry them with a soft cloth. Check if scaling has been formed. If so, proceed with cleaning of the cell plates (see chapter 10).

6. INSTALLATION

6.1 CONTROL UNIT INSTALLATION

The Emaux **SSCmini**® control unit is contained in a raintight enclosure that is suitable for outdoor mounting (IPX4 rating). However, the following points must be taken into consideration for a correct installation of the control unit:

1. Install the Control Unit using the mounting template provided with the package. The unit should be installed in a minimum distance of 3 meters from the swimming pool, 1.5 meters from the ground, within 2 meters from electrical enclosure, and within 3 meters from where the cell will be installed.
2. Fix the mounting template on the wall and drill 4 holes with a diameter of 8mm in the wall according to the mounting template (Figure 1). Use expansion bolts to support the control unit.
3. Hang the control box on the fixed bolts (Figure 2) and make sure that the power cable and cell cable also reach the Control Unit.
4. Don't install the control unit under direct sun light.
5. The control unit should be installed away from chemicals storage.
6. The unit must be kept away from heat sources and any equipment which produce heat.
7. Plug-in power supply into a suitable weatherproof outlet socket with circuit breaker.

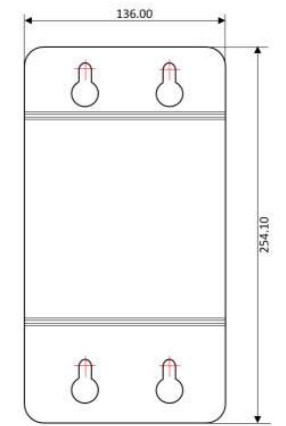

Figure 1

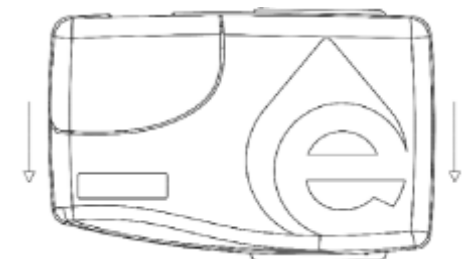

Figure 2

6.2 ELECTROLYTIC CELL INSTALLATION

Please follow the recommendations below to install the electrolytic cell properly:

1. The electrolytic cell should be mounted once the installation of all other swimming pool equipment is completed (filtration pump, filter, heating system).
2. The electrolytic cell is designed to install in PVC pool plumbing. The opening of the cell holder must be placed upright to enable the maintenance of titanium plates. To install the cell, cut off at least 187mm of pipe. Fix the electrolytic holder on the pipe, put the electrodes into the cell. Make the electrode cable go through the nut (Figure 3).
3. Connect the unions to the pipe and make necessary adjustments for a proper connection. Once adjusted, fix the connection with PVC glue and tighten the union nuts.
4. Place the electrodes inside the holder and tighten the nut of the cell; connect the electrode cable to the control unit; tighten the nut to ensure the good contact (Figure 4).

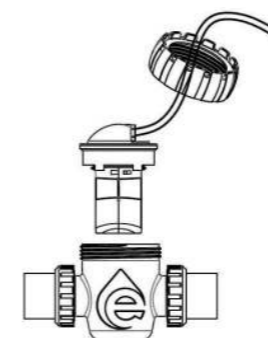

Figure 3



Figure 4

Note: the cell can also be installed in a vertical position.

7. START-UP

Before starting Emaux **SSCmini**[®] unit, the following points have to be taken into consideration:

1. Check if the filter is completely clean, and ensure that the swimming pool and the installation do not contain any metals dissolved or algae.
2. Ensure that the heating equipment (if any) is suitable for use in salt water.
3. Ensure that chemical parameters of pool water are within the recommended range (see Chapter 6).
4. Run your filtration system for 24 hours before starting salt chlorinator so that salt in the swimming pool is completely dissolved.

For start-up, set the system at 50% of working time. It will take a few days of adjustments to find the most appropriate setting according to the chlorine demand of your swimming pool. Once determined, only minor adjustments might be necessary in cases of splashing, backwashing, rain, etc.

The temperature of the water is a parameter that effects the chlorine production. When the temperature rises, chlorine will be easily volatilized affecting sanitizing effect. The water temperature should be within the range of 15-40°C. The Emaux **SSCmini**[®] will not produce chlorine at temperatures below 10° C.

The desired level of chlorine generation should be modified according the following parameters:

1. Pool water temperatures increases or decreases significantly
2. When there is a higher load of bather than normally
3. When the cell's life time is finishing
4. In a long period of inactivity or winterizing

8. OPERATION

SSCmini[®] salt chlorinator is managed through a control panel that regulates chlorine production and informs about operation status.

LED INDICATORS

1. **Cell life low.** Illuminates when the cell reaches the end of its expected life. In this case, the cell electrodes have to be replaced.
2. **No flow.** Water flow is not detected, or water flow is too low. If operation schedule is not active, no action should be done, otherwise refer to the Troubleshooting guide (Chapter 12).
3. **Alarm.** The unit is not working properly. Refer to the Troubleshooting guide (Chapter 12).
4. **Stand-by.** The unit is in-between operation cycles.
5. **Normal operation.** Electrolytic cell is generating chlorine under normal conditions.
6. **Superchlorination.** Superchlorination mode is active. Electrolytic cell will be generating chlorine during 24 hours.
7. **Work schedule.** These 10 LEDs, from 1 to 10, correspond to a working hour, each LED represents 6 minutes. If all 10 LEDs illuminate, the unit will be generating chlorine without stop. If 5 LEDs illuminate, the unit will be generating chlorine during 30 minutes of each working hour.

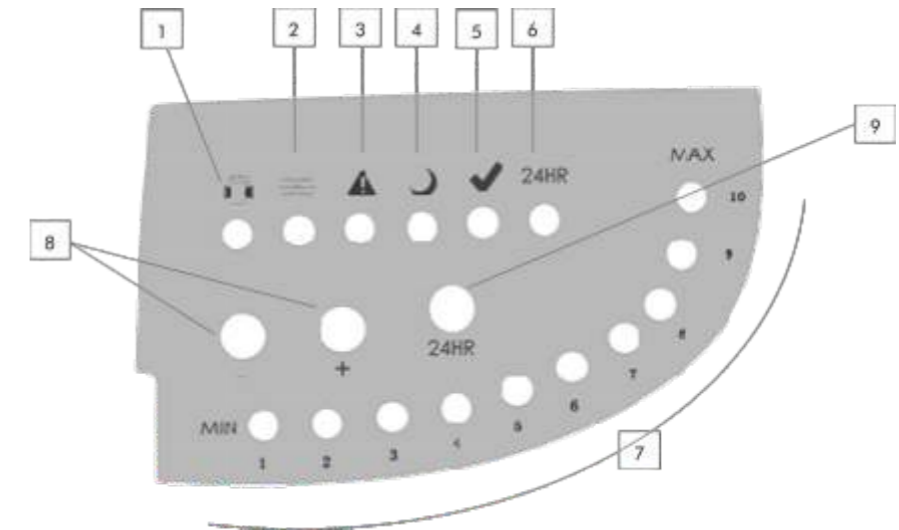

CONTROL BUTTONS

8. **Work schedule control:** Press "+" and "-" to adjust working time. The LEDs below will illuminate as explained above.
9. **Superchlorination:** Press the button to activate Superchlorination mode. The cell will be generating chlorine during 24 hours. To exit superchlorination mode, press the button again.

EXAMPLE

If you start **SSCmini**[®] at 9:00 and set the work schedule at 5, then the unit will be working from 9:00 to 9:30 (**Normal operation LED is ON**) and in stand-by mode from 9:30 to 10:00 (**Stand-by LED is ON**).



09:00 – 09:30

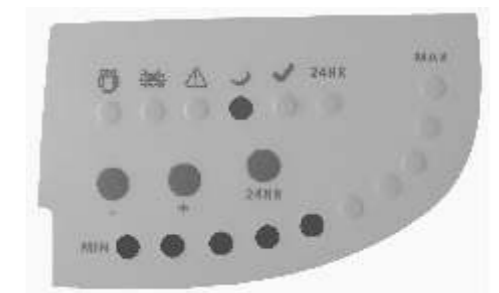

09:30 – 10:00

A new cycle will start at 10:00 until 10:30, and so on.



10:00 – 10:30

If you activate Superchlorination mode at 10:30 (**Superchlorination LED is ON**), then the unit will be working until 10:30 of the next day and will exit Superchlorination mode afterwards. Once finished Superchlorination, the schedule will be restored and a new cycle will start.