

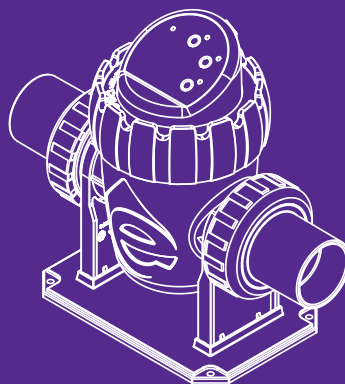

SSCnano

INSTALLATION AND OPERATION
MANUAL



USER MANUAL



RoHS
DIRECTIVE
2011/65/Eu

SAA

Model: SSCnano

TABLE OF CONTENT

PAGE	
2 WARNING
2 1. PRODUCT INTRODUCTION
2 2. SPECIFICATIONS
	2.1 DIMENSION
	2.2 ACCESSORIES
4 3. INSTALLATION & OPERATION
	3.1 INSTALLATION
	3.1.1 CONNECT WITH 50MM (1½") UNION
	3.1.2 CONNECT WITH THE 32MM(1¼") & 38MM(1½") FLEXI HOSE CONNECTOR
5 3.2 OPERATION
	3.2.1 ON / OFF
	3.2.2 CHLORINE PERCENTAGE
	3.2.3 TIMER
	3.2.4 MEMORY MODE
8 4. TROUBLESHOOTING
9 5. SPARE PARTS LIST
10 6. TERMS OF THE WARRANTY

WARNINGS



This product should be installed and repaired by a technician who is qualified in the installation and maintenance of pool/spa products. Please read this manual before installing the product. The instructions in this manual can be followed exactly. Disconnect electrical power before removing the cover for servicing unit. Replace all screws and covers before reconnecting the unit to electric power. Incorrect installation and/or operation can cause serious injury, property damage, or death. To reduce the risk of injury, do not permit children to use this product. Improper installation and/or operation will void the warranty.

1. PRODUCT INTRODUCTION

SSCnano is an innovative inline salt chlorinator that seamlessly synchronizes with the pump. With its preset timer offering flexible options and 4 chlorine production modes, SSCnano provides complete control over the chlorination process. Enjoy the benefits of long cell life and reduced chemical usage, thanks to its efficient and environmentally friendly design. Compact and user-friendly, SSCnano revolutionizes the experience of chlorine production.

Salt chlorination is a method of sanitizing swimming pools with chlorine generated by electrolysis. The electrolysis is achieved by passing the salt water solution through a weak electric charge in an electrolytic cell, which converts sodium chloride (salt) in the water into chlorine gas. The gas is dissolved in the water and becomes sodium hypochlorite (liquid chlorine).

2. SPECIFICATIONS

Code	Model	Input Voltage/ Frequency	Salt Level	Cell Production Rate	Maximum Working Pressure	Cell Connections	Working Temperature	Min. Flow	Max Pool Volume
9130045	SSCnano4	110-240V /50-60 Hz	3500 ppm	4g/hr	2.5 bar	1.5"/ 50mm and 32mm&38mm union	10-45°C	3m ³ /hr	20m ³
9130046	SSCnano6			6g/hr					30m ³
9130047	SSCnano8			8g/hr					40m ³
9130048	SSCnano10			10g/hr					50m ³

2.1 DIMENSION(mm)

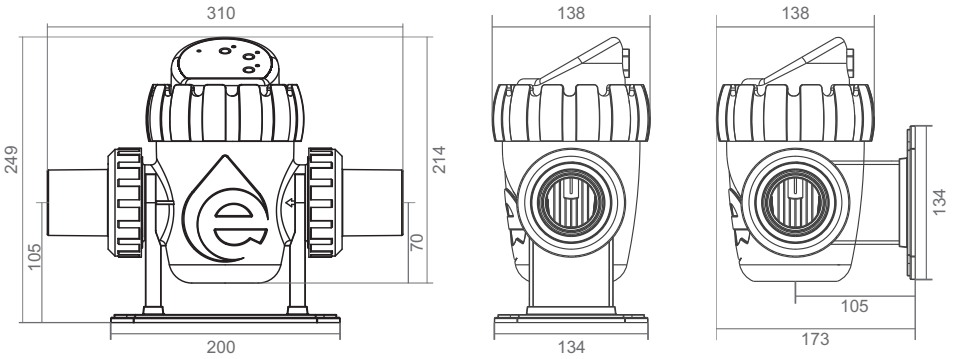

2.2 ACCESSORIES

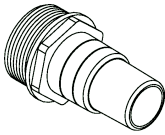

32mm(1¼”) &
38mm(1½”) Flexi hose
connector

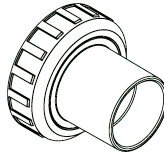

50mm (1½”) union

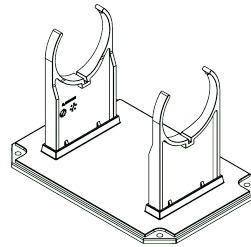

Mounting Stand

- 32mm(1¼”) & 38mm(1½”) Flexi hose connector and 50mm (1½”) union installation, please refer to Part 3, Installation & Operation.
- The mounting stand is allowed the SSCnano place stand on the floor or wall mount.

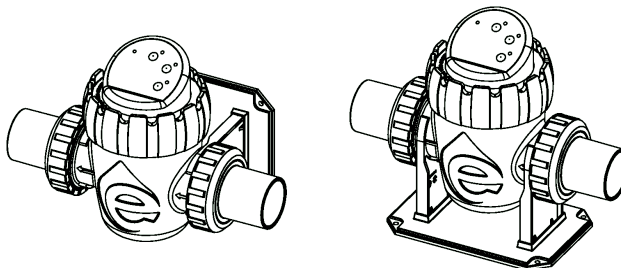

[Fig.1] Stand and Wall Mount

3. INSTALLATION & OPERATION

Check the pool system regularly and make sure the parameters are within the range:

Parameter	Target range
Salinity	3,000 to 4,000 ppm
pH level	7.2 to 7.4
Water temperature	10 - 45°C
Flow rate	3 to 10 m ³ /h

3.1 INSTALLATION

The SSCnano has an arrow mark on its body [Fig.2] showing the water flow direction. It is designed to operate with water flow rates between 3-10 m³/h. Please refer to the pipe manufacturer specifications for recommended maximum flow rate. It is a must to use a bypass loop with flow control valve if the flow rate is over 8 m³/h. [Fig.3] showing the general installation. Adding a valve before and after SSCnano to make sure the isolation between SSCnano and the facilitate when maintenance.

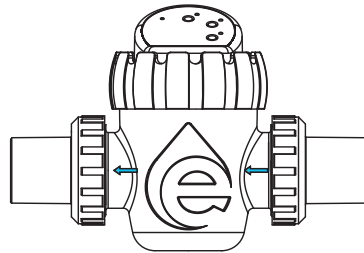

[Fig.2]

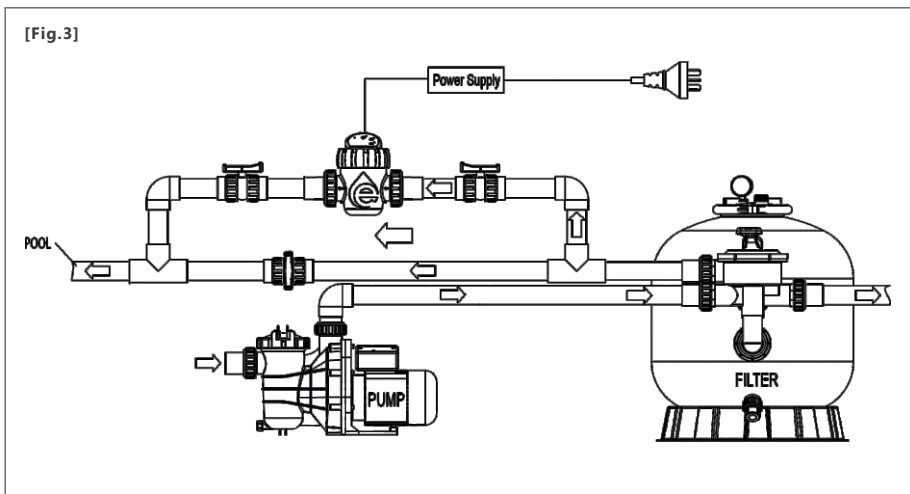

[Fig.3]

3.1.1 CONNECT WITH 50MM (1½") UNION

SSCnano can be installed either horizontal or vertical. The union is designed for imperial 1½" pipe and metric 50mm pipe. Pipes are required gluing to fix.

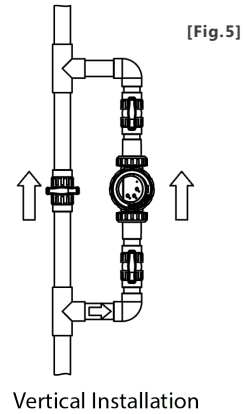
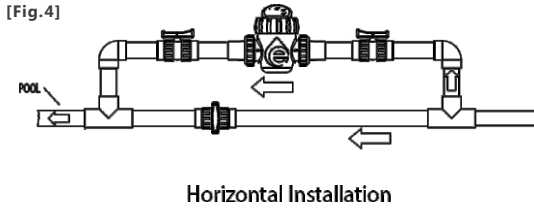

3.1.2 CONNECT WITH THE 32MM(1¼") & 38MM(1½") FLEXI HOSE CONNECTOR

The 32mm(1¼") & 38mm(1½") Flexi hose connector can let the SSCnano use with flexible pipes, shown as [Fig.6].

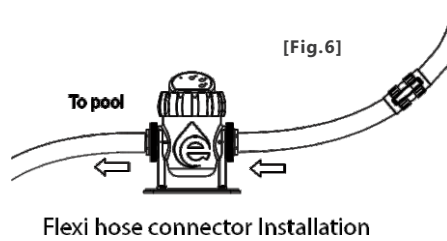

3. 2 OPERATION

3.2.1 ON / OFF

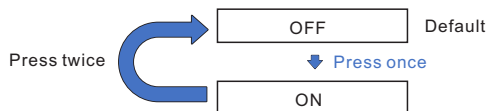

3.2.2 CHLORINE PERCENTAGE

Optimize the chlorine percentage, to suit pool size/ temperature.

If the pool size is smaller than the max pool size of the SSCnano, lower the chlorine percentage proportionally. (e.g. Using SSCnano4 for a 10m³ pool, press Ⓢ twice to 50% of the max chlorine percentage rate.)

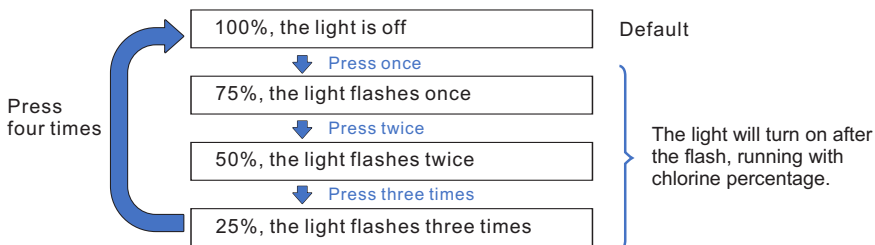

Operating during winter:

The lower the water's temperature, the lower the salt water's conductivity will be. This in turn will cause the SSCnano to work much harder than normal to produce chlorine. Algae and bacteria don't grow well in cold environments. Thus, very little chlorine is needed, simply adjust the chlorine percentage to an ideal rate.

During winter (e.g. temperature drops below 16°C), you can reduce to 25 % of the max chlorine percentage to minimize chlorination for your pool.

Low-temperature protection:

When the water temperature is below 10°C, SSCnano will stop functioning. (Ⓢ), NaCl light will flash, refer to Part 4, Troubleshooting). This feature prolongs the service life of the cell.

3.2.3 TIMER

The timer setting can synchronize with the expected operation time for energy saving. (e.g. To set the timer ON at 9:00 and off at 17:00. When it is 9:00 a.m., press Ⓢ twice to set the timer of SSCnano to 8 hours. It will stop running at 5:00 p.m. and function again at 9:00 a.m. the next morning.)

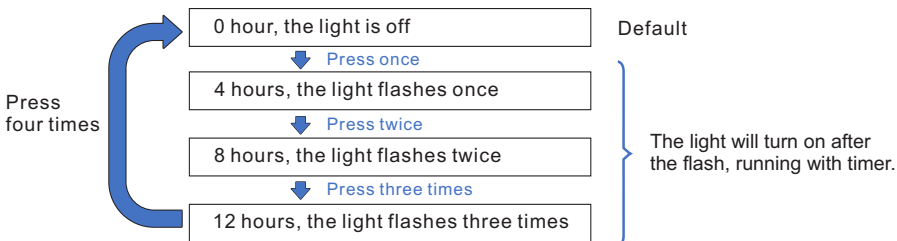

Note:

- 1) All setting will be saved when press ON/OFF to power off the SSCnano.
- 2) Power cut SSCnano will reset all settings to factory default.

3.2.4 MEMORY MODE

This function is for connecting the SSCnano to an automation system device. The SSCnano will start chlorine generation once powered up. The chlorine percentage setting will be saved after power down. (e.g. The chlorine percentage of the SSCnano was set to 50%. The setting will be kept if the power is cut and turned back on.)

Note: The set time will not be saved and reset to default when power down.





To enter memory mode:

During OFF stage, press and hold for 5 seconds to enter the memory mode. (The light will flash three times. It will flash once every 30 seconds if the SSCnano is running in memory mode.)

To cancel memory mode:

During ON stage, press and hold for 5 seconds to cancel the memory mode. (The light will flash three times after canceling the mode and then stop.)

4. TROUBLESHOOTING

LIGHT FLASH CONTINUOUSLY	POSSIBLE CAUSE	SOLUTION
 <p>NaCl</p>	<p>Low salinity level. Salinity below 2500ppm, causing the production rate of chlorine is being reduced.</p>	<p>The normal operating range is 3,000 to 4,000 ppm. Add salt to pool to achieve 3500 ppm to ensure. Once the correct level has been reached. The chlorinator should operate normally.</p>
 <p>NaCl, %, ⏻</p>	<p>No flow/ Flow rate too small/ error in flow sensor</p>	<p>The normal operating flow rate range is between 3 to 10 m³/h. Make sure the flow rate is sufficient. The bypass is proving enough water to the cell and the valves are correctly set. If all the above were confirmed, the flow sensor might have fatal error, contact customer support for a replacement.</p>
 <p>NaCl, 🌡️</p>	<p>Water temperature is not within the operating range or error in temperature sensor</p>	<p>Make sure the temperature is between 10 to 45°C. If the above were confirmed, the temperature sensor might have a fatal error, contact customer support for a replacement.</p>
 <p>⏻, %, 🌡️</p>	<p>Incorrect input voltage</p>	<p>Make sure the unit is connected to the SSCnano paired adaptor.</p>
 <p>All lights are flashing</p>	<p>Cell lifetime ran out</p>	<p>Check the wiring connection, and restart SSCnano. If all the lights still flash, please contact customer support for a replacement.</p>
<p>No function</p>	<p>Wiring issues</p>	<p>Make sure the power supply is connected and input the correct voltage [110-240V, 50-60Hz]. If it still having no function, please contact customer support for a replacement.</p>

5. SPARE PARTS LIST

Key No.	Part No.	Description	QTY
1	530135108	Electrolytic cell nut	1
2	E1330069	SSCnano4 Electrolytic cell (4 grams)	1
	E1330070	SSCnano6 Electrolytic cell (6 grams)	1
	E1330071	SSCnano8 Electrolytic cell (8 grams)	1
	E1330072	SSCnano10 Electrolytic cell (10 grams)	1
3	1062510186	SSCnano PCB	1
4	111010013	SSCnano O-Ring	1
5	111040010	D116.6X1.5 O-Ring	1
6	5300410081	Electrolyser housing	1
7	111202472	O-Ring D70 x d60 x 6	2
8	430170991	2.0" Union Nut (black)	2
9	430300943	1.5" Union	2
10	111142481	O-Ring d42x3	2
11	430091071	32x38 Union	2
12	5203410081	Stand	2
13	5203410083	Mounting Stand Base	1
14	106090062	DC power supply (4 & 6 grams)	1
	106090063	DC power supply (8 grams)	1
	106090064	DC power supply (10 grams)	1

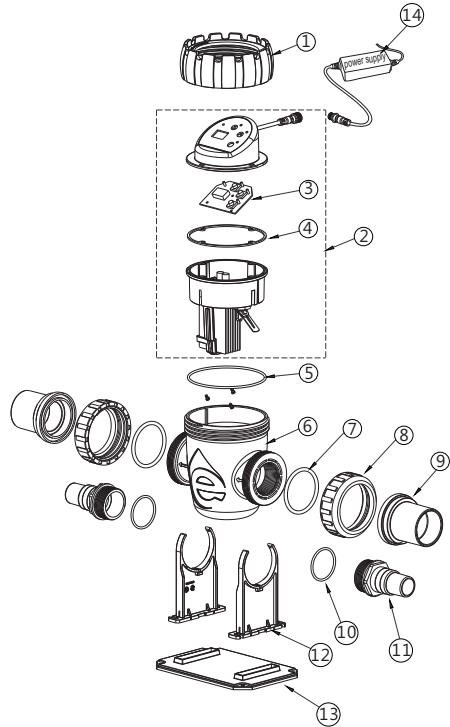

6. TERMS OF THE WARRANTY

As original purchaser of this equipment have purchased from Emaux Water Technology Co Ltd, through Authorized International Distributor or Dealer, warrants its products free from defects in materials and workmanship under normal use during warranty period. The warranty period begins on the day of purchase and extends only to the original purchaser. It is not transferable to anyone who subsequently purchases the product from you. It excludes all expendable parts. During the warranty period, Emaux authorized reseller will repair or replace defective parts with new parts or, at the option of Emaux, serviceable used parts that are equivalent or superior to new parts in performance. This Limited Warranty extends only to products purchased from Emaux authorized reseller. This Limited Warranty does not extend to any product that has been damaged or rendered defective

- (a) as a result of accident, misuse or abuse;
- (b) as a result of an act of God;
- (c) by operation outside the usage parameters stated herein;
- (d) by the use of parts not manufactured or sold by Emaux;
- (e) by modification of the product;
- (f) as a result of war or terrorist attack; or
- (g) as a result of service by anyone other than Emaux authorized reseller or authorized agent.

EXCEPT AS EXPRESSLY SET FORTH IN THIS WARRANTY, EMAUX MAKES NO OTHER WARRANTIES EXPRESSED OR IMPLIED, INCLUDING ANY IMPLIED WARRANTIES OR MERCHANTABILITY AND FITNESS FOR A PARTICULAR PURPOSE. EMAUX EXPRESSLY DISCLAIMS ALL WARRANTIES NOT STATED IN THIS LIMITED WARRANTY. ANY IMPLIED WARRANTIES THAT MAY BE IMPOSED BY LAW ARE LIMITED TO THE TERMS OF THIS EXPRESS LIMITED WARRANTY.

EMAUX WATER TECHNOLOGY CO., LTD

ADDRESS FLAT A-D, 20/F., KAI BO 22, 22 WING KIN ROAD,
KWAI CHUNG, HONG KONG
PHONE +852 2832 9880

 **YOUR PREMIER SUPPLIER**

www.emauxgroup.com