



PRECISE, RELIABLE AND VERSATILE FLUID HANDLING

For measurement of the PH, Redox / ORP value

CyberSync[®] Dosing System



ACCURATE AND RELIABLE

The Emaux "CyberSync" Peristaltic Dosing Pump series is indeed a groundbreaking addition to pool maintenance technology. Designed for swimming pools ranging from 30m³ to 150m³, it offers three versions: Core-Pro, Core-Plus, and Core, with five different models to cater to various needs. Utilizing peristaltic technology, these pumps ensure precise and reliable dosing, keeping pools balanced and sanitized. The user-friendly control panel, chemical-resistant BTP tube, and durable shield enhance its dependability. Additionally, its wide voltage range (110V to 240V) simplifies installation across different electrical systems, making it an excellent choice for maintaining a crystal-clear pool.



Dot matrix LCD display

User-friendly control panel

Chemical & UV resistant shield

Precision-Engineered POM rollers

Rotating module smooth dosing

Reliable BTP tube

PP tube holder

CE CB SAA   IPX4 

Technical Overview:

Chemical Concentration:

Liquid Chlorine up to 30%

Muriatic acid up to 40%

Sulfuric acid up to 40%

Operating Voltage: 110-240V 50/60Hz

Max Dosing Rate: 3 L/hour

Consumption: 20 watt

Pressure: 1.5 bar [22 psi]

Strainer / injector Tube Size: 4 x 6 (mm) tube

Core-Pro Version



The Emaux CyberSync Core-Pro is an advanced peristaltic dosing pump designed for seamless automatic dosing. It integrates with Emaux pH or ORP probes, ensuring precise and comprehensive dosing automation. Additionally, it supports external connectivity for pump control, level probes, alarms, and other dosing pumps, offering a straightforward and complete automation solution for various dosing requirements. This makes it an excellent choice for maintaining optimal water quality with minimal manual intervention.

| | |
|------------------------------|---------------------------|
| Model: | DP300-X |
| Display: | LED (Dot Matrix) |
| Depoly Probe: | ORP or pH |
| External connection*: | Pump, Alarm, Level sensor |

*Max power for external dosing pump: 50w

| Code | Model | Pressure bar [psi] | Max dosing rate L/hour | Measurable range | Operating voltage v | Input power w |
|---------|-------------|--------------------|------------------------|-------------------|---------------------|---------------|
| 9130113 | DP300-X-ORP | 1.5 [22] | 3 | ORP: 300 to 900mV | 110-240 | 20 |
| 9130117 | DP300-X-PH | 1.5 [22] | 3 | pH4 - pH10 | 110-240 | 20 |



Core Version

Model: DP300

Display: LED

The Emaux CyberSync Core is indeed a versatile dosing solution designed for ease of use. It allows users to effortlessly adjust the dosing rate, ensuring precise control over chemical levels.

| Code | Model | Pressure bar [psi] | Max dosing rate L/hour | Operating voltage v | Input power w |
|---------|-------|--------------------|------------------------|---------------------|---------------|
| 9130116 | DP300 | 1.5 [22] | 3 | 110-240 | 20 |

Core-Plus Version

The Emaux CyberSync Core-Plus is a fantastic solution for maintaining optimal pool chemistry! Its automatic dosing feature for ORP and pH control, along with the user-friendly LED display, makes it easy to monitor and adjust water quality in real-time. Whether you choose the ORP or pH version, this device ensures that your pool remains in perfect balance, providing a hassle-free experience for pool owners.



Model: DP300-ORP

Display: LED

Probe: ORP



Model: DP300-PH

Display: LED

Probe: pH



| Code | Model | Pressure bar [psi] | Max dosing rate L/hour | Measurable range | Operating voltage v | Input power w |
|---------|-----------|--------------------|------------------------|-------------------|---------------------|---------------|
| 9130114 | DP300-ORP | 1.5 [22] | 3 | ORP: 300 to 900mV | 110-240 | 20 |
| 9130115 | DP300-PH | 1.5 [22] | 3 | pH4 - pH10 | 110-240 | 20 |

Product Dimensions

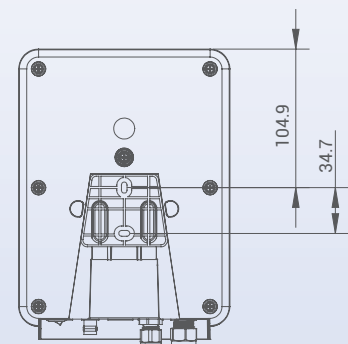
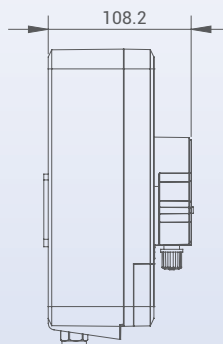
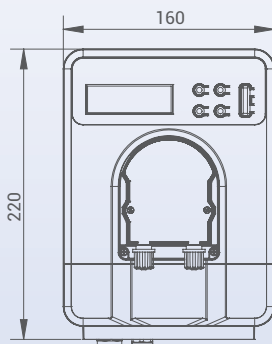

Installation Diagram

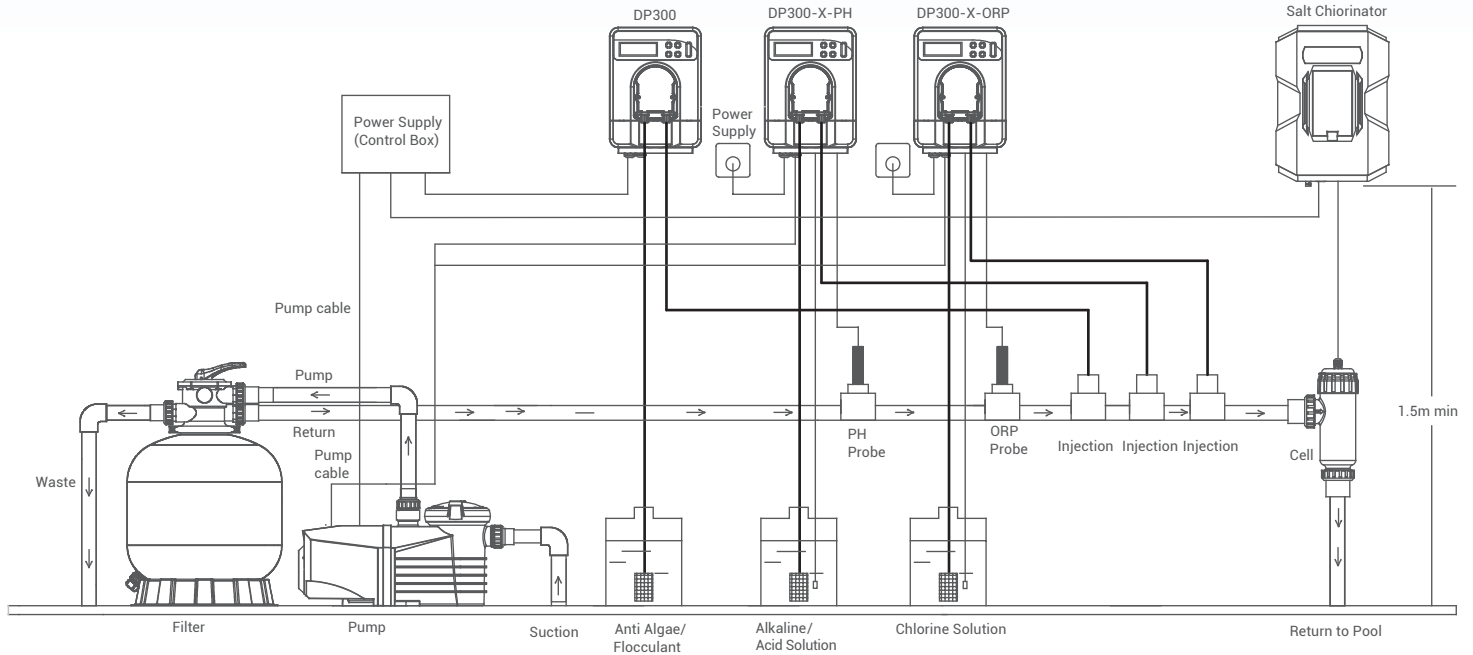

Probe and Accessories Specifications

| Code | Product Name | Parameter | Photo | DP300-X-ORP | DP300-X-PH | DP300-ORP | DP300-PH | DP300 |
|------------|--------------------------------------|--|-------|-------------------------------------|-------------------------------------|-------------------------------------|-------------------------------------|-------------------------------------|
| 106090074 | ORP probe | Pressure: 7 bar Material: epoxy Measuring range: -300 to 900mV (with 3m signal line) Electrode diameter: 12mm | | <input checked="" type="checkbox"/> | <input checked="" type="checkbox"/> | <input checked="" type="checkbox"/> | <input checked="" type="checkbox"/> | <input checked="" type="checkbox"/> |
| 106090073 | pH probe | Pressure: 7 bar Material: epoxy Measuring range: 0- 14 (with 3M signal line) Electrode body diameter: 12mm | | <input checked="" type="checkbox"/> | <input checked="" type="checkbox"/> | <input checked="" type="checkbox"/> | <input checked="" type="checkbox"/> | <input checked="" type="checkbox"/> |
| 106090075 | Probe holder | ½" male thread | | <input checked="" type="checkbox"/> | <input checked="" type="checkbox"/> | <input checked="" type="checkbox"/> | <input checked="" type="checkbox"/> | <input checked="" type="checkbox"/> |
| 1090010392 | 256 buffer solution | 256mV, 30mL | | <input checked="" type="checkbox"/> | <input checked="" type="checkbox"/> | <input checked="" type="checkbox"/> | <input checked="" type="checkbox"/> | <input checked="" type="checkbox"/> |
| 109007168 | pH probe buffer solution pH4 and pH7 | pH 4.0 and pH 7.0, 30mL | | <input checked="" type="checkbox"/> | <input checked="" type="checkbox"/> | <input checked="" type="checkbox"/> | <input checked="" type="checkbox"/> | <input checked="" type="checkbox"/> |
| 87990306 | Dosing pipe fitting | Pressure: 7 bar PE Tube: 4x6 tube x 1 pc PVC Tube: 4x6 tube x 1 pc PVDF Injector: ½" meal thread x 1 pc PVDF strainer: with valve x 1 pc | | <input checked="" type="checkbox"/> | <input checked="" type="checkbox"/> | <input checked="" type="checkbox"/> | <input checked="" type="checkbox"/> | <input checked="" type="checkbox"/> |
| 104130040 | Level probe | With 2m signal line | | <input checked="" type="checkbox"/> | <input checked="" type="checkbox"/> | <input checked="" type="checkbox"/> | <input checked="" type="checkbox"/> | <input checked="" type="checkbox"/> |
| 540200008 | Wall mount holder | With screw | | <input checked="" type="checkbox"/> | <input checked="" type="checkbox"/> | <input checked="" type="checkbox"/> | <input checked="" type="checkbox"/> | <input checked="" type="checkbox"/> |

CyberSync

**PRECISE, RELIABLE AND
VERSATILE FLUID HANDLING**

FOR MEASUREMENT OF THE PH, REDOX / ORP VALUE



Core Version

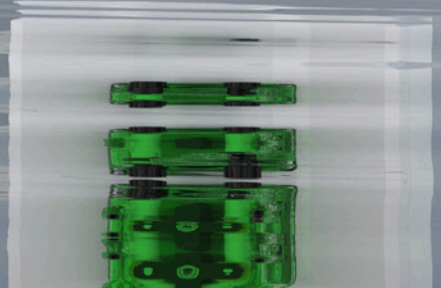
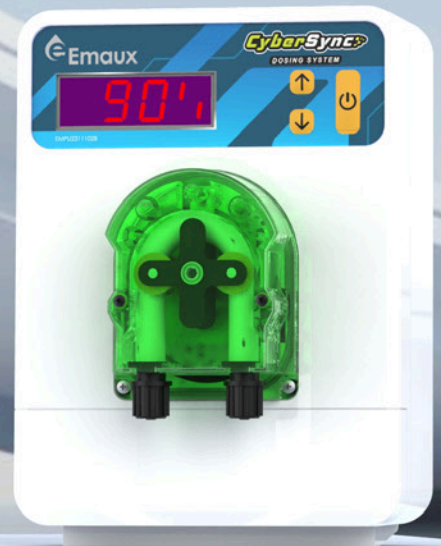

Product features:

- Easy installation and maintenance
- User-friendly interface and operation
- Precise and reliable pool chemical control
- Versatile model option
- Adjustable flow rate control

Core-Plus pH Version

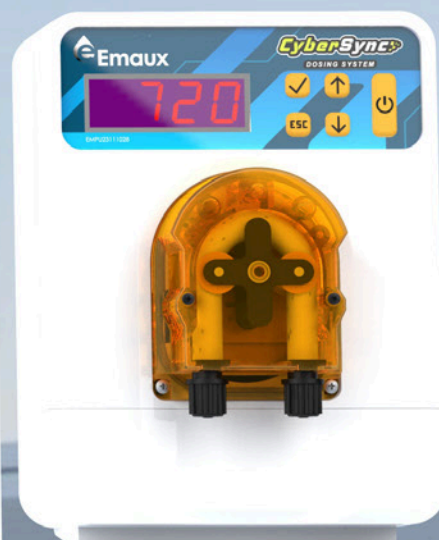

**Core-Plus
ORP Version**



EMAUX WATER TECHNOLOGY CO., LTD

ADDRESS: 2/F, Lockhart Centre, No. 301-307 Lockhart Road,
Wanchai, Hong Kong
PHONE +852 2832 9880
www.emauxgroup.com

 **YOUR PREMIER SUPPLIER**