

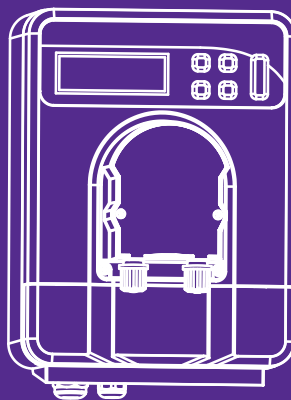

# DP300

## INSTALLATION AND OPERATION MANUAL



# USER MANUAL



RoHS  
DIRECTIVE  
2011/65/Eu

SAA

Model: DP300

# TABLE OF CONTENT

PAGE	
2	..... WARNING
2	..... 1. PRODUCT INTRODUCTION
3	..... 2. SPECIFICATIONS
	2.1 DIMENSION (MM)
	2.2 ACCESSORIES
5	..... 3. INSTALLATION & OPERATION
	3.1 INSTALLATION
	3.1.1 PROBE INSTRUCTION: (DP300-X, DP300-ORP, DP300-PH)
	3.1.2 ELECTRICAL TERMINALS (DP300-X ONLY)
8	..... 3.2 FUNCTION AND MENU
	3.2.1 KEY FEATURE
	3.2.2 DISPLAY
	3.2.3 PROBE CALIBRATION
12	..... 3.3 SETUP MENU
	3.3.1 BASIC MENU (AUTOMATIC MODE)
	3.3.2 FULL MENU
16	..... 3.4 OPERATION
	3.4.1 POWER UP DELAY
	3.4.2 PRIMING
	3.4.3 AUTO MODE
	3.4.4 DOSING MODE
18	..... 3.5 GENERAL MAINTENANCE
20	..... 4. TROUBLESHOOTING
21	..... 5. SPARE PARTS LIST
26	..... 6. TERMS OF THE WARRANTY

---

## WARNINGS

---



This product should be installed and repaired by a technician who is qualified in the installation and maintenance of indoor pool/spa products. Please read this manual before installing the product. The instructions in this manual can be followed exactly. Disconnect electrical power before removing the cover for servicing unit. Replace all screws and covers before reconnecting the unit to electric power. Incorrect installation and/or operation can cause serious injury, property damage, or death. To reduce the risk of injury, do not permit children to use this product. Improper installation and/or operation will void the warranty.

### IMPORTANT SAFETY INSTRUCTIONS

When installing and using this electrical equipment, basic safety precautions should always be followed, including the following:

- 1) READ AND FOLLOW ALL INSTRUCTIONS.
- 2) WARNING–To reduce the risk of injury, do not permit children to use this product unless they are closely supervised at all times.
- 3) WARNING–Risk of Electric Shock. Connect only to a branch circuit protected by a ground-fault circuit interrupter (GFCI). Contact a qualified electrician if you cannot verify that the circuit is protected by a GFCI.
- 4) The unit must be connected only to a supply circuit that is protected by a ground-fault circuit-interrupter (GFCI). Such a GFCI should be provided by the installer and should be tested on a routine basis. To test the GFCI, push the test button. The GFCI should interrupt power. Push the reset button. Power should be restored. If the GFCI fails to operate in this manner, the GFCI is defective. If the GFCI interrupts power to the pump without the test button being pushed, a ground current is flowing, indicating the possibility of an electric shock. Do not use this pump. Disconnect the pump and have the problem corrected by a qualified service representative before using.
- 5) Do not bury cord. Locate cord to minimize abuse from lawn mowers, hedge trimmers, and other equipment.
- 6) WARNING – To reduce the risk of electric shock, replace damaged cord immediately.
- 7) WARNING – To reduce the risk of electric shock, do not use extension cord to connect unit to electric supply; provide a properly located outlet.
- 8) Mounting location of the supply unit at least 1.5 m from the pool.
- 9) Proper disassembly and reassembly of the cell for cleaning.
- 10) The unit installation position should be at least 1.5m away from the swimming pool.

---

## 1. PRODUCT INTRODUCTION

---

The Emaux "CyberSync" Peristaltic Dosing Pump series is indeed a groundbreaking addition to pool maintenance technology. Designed for swimming pools ranging from 30m<sup>2</sup> to 150m<sup>2</sup>, it offers three versions: Core-Pro, Core-Plus, and Core, with five different models to cater to various needs. Utilizing peristaltic technology, these pumps ensure precise and reliable dosing, keeping pools balanced and sanitized. The user-friendly control panel, chemical-resistant BTP tube, and durable shield enhance its dependability. Additionally, its wide voltage range (110V to 240V) simplifies installation across different electrical systems, making it an excellent choice for maintaining a crystal-clear pool.

## 2. SPECIFICATIONS

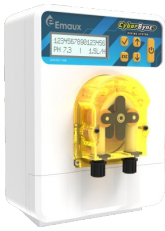

**DP300-X**



**DP300-ORP**



**DP300-PH**



**DP300**

The Emaux CyberSync Core-Pro is an advanced peristaltic dosing pump designed for seamless automatic dosing. It integrates with Emaux pH or ORP probes, ensuring precise and comprehensive dosing automation. Additionally, it supports external connectivity for pump control, level probes, alarms, and other dosing pumps, offering a straightforward and complete automation solution for various dosing requirements. This makes it an excellent choice for maintaining optimal water quality with minimal manual intervention.

The Emaux CyberSync Core-Plus is a fantastic solution for maintaining optimal pool chemistry! Its automatic dosing feature for ORP and pH control, along with the user-friendly LED display, makes it easy to monitor and adjust water quality in real-time. Whether you choose the ORP or pH version, this device ensures that your pool remains in perfect balance, providing a hassle-free experience for pool owners.

The Emaux CyberSync Core is indeed a versatile dosing solution designed for ease of use. It allows users to effortlessly adjust the dosing rate, ensuring precise control over chemical levels.

Code	Model	Pressure Bar [psi]	Max Flow L/hr [gpm]	Range	Operating voltage	Power
9130113	DP300-X-ORP	1.5 [22]	3 [0.0132]	pH: 4-10 ORP: 300-900mV	110-240V	20W
9130117	DP300-X-PH					
9130114	DP300-ORP			pH: 4-10 ORP: 300-900mV		
9130115	DP300-PH					
9130116	DP300					

Series	Model	Main unit	Accessory kit
Core-Pro	DP300-X-ORP	DP300-X	ORP probe, probe holder, ORP cal kit, fitting set, wall mount holder and level switch
	DP300-X-PH		PH probe, probe holder, PH cal kit, fitting set, wall mount holder and level switch
Core-Plus	DP300-ORP	DP300-ORP	ORP probe, probe holder, ORP cal kit, fitting set, wall mount holder.
	DP300-PH	DP300-PH	PH probe, probe holder, PH cal kit, fitting set, wall mount holder.
Core	DP300	DP300	fitting set, wall mount holder.

## 2. 1 DIMENSION(mm)

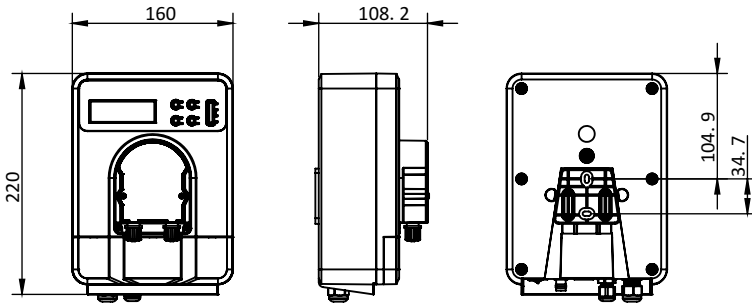

## 2. 2 ACCESSORIES

Product name	Parameter	DP300-X-ORP	DP300-X-PH	DP300-ORP	DP300-PH	DP300
ORP probe	Pressure: 7 bar Material: epoxy Range: 300-900mV (w/ 3m signal line) Electrode body dia.: 12mm	✓	✗	✓	✗	✗
PH probe	Pressure: 7 bar Material: epoxy Range: 0-14 (w/ 3m signal line) Electrode body dia.: 12mm	✗	✓	✗	✓	✗
Probe holder	½" male thread	✓	✓	✓	✓	✗
256 buffer solution	256mV, 30mL	✓	✗	✓	✗	✗
PH probe buffer solution pH4 and pH7	pH 4.0 and pH 7.0, 30mL	✗	✓	✗	✓	✗
Dosing pipe fitting	Pressure: 7 bar PE Tube: 4x6 tube x 1 pc PVC Tube: 4x6 tube x 1 pc PVDF Injection fitting: ½" male thread x 1 pc PVDF strainer: with valve x 1 pc	✓	✓	✓	✓	✓
Level probe	w/ 2m signal line	✓	✓	✗	✗	✗
Wall mount holder	With screw	✓	✓	✓	✓	✓

---

## 3. INSTALLATION & OPERATION

---

### 3.1 Installation:

#### Install Position:

- Position the pump according to the guidelines illustrated in Figure 3. Take note that the pump can be installed either below or above the liquid level to be dosed. However, ensure that the vertical distance between the pump and the liquid does not exceed 2 meters.
- If the liquid being pumped generates aggressive vapors, exercise caution. Avoid installing the pump above the storage tank, unless the tank is completely sealed to prevent the escape of vapors.
- Carefully following these installation instructions will help ensure the proper functioning of the pump and minimize any potential risks associated with aggressive vapors.

#### Tubing:

- Inlet Tubing - (Compression tube models) -Locate the inlet fitting of the Pump Tube. Remove the tube nut. Push the clear PVC suction tubing onto the compression barb of the fitting. Use the tube nut to secure the tube. Hand tighten only.
- Footvalve/ Strainer – Trim the inlet end of the suction tubing so that the strainer will rest in the vertical position, approximately one inch from the bottom of the solution tank. This will prevent sediment from clogging the strainer. Loss of prime may occur if the footvalve is permitted to lay on the bottom of the solution tank in a horizontal position. Press the footvalve/ strainer into the end of the tube. Drop the strainer into the solution tank.
- Outlet tubing – Locate the outlet fitting of the pump head, remove the tube nut. Push the rigid outlet (discharge) tubing onto the compression barb of the fitting. Use the tube nut to secure the tube. Hand tighten only.  
Trim the other end of the outlet tube leaving only enough slack to connect it to the Injection / Check valve Fitting. Increasing the length of the outlet tube increases the back pressure at the pump head, particularly when pumping viscous fluids.  
Keep the inlet and outlet tubes as short as possible

#### Injection/ Check Valve

- Injection/ Check Valve is designed to install directly into ½" female pipe threads. This fitting will require periodic cleaning, especially when injection fluids that calcify such as sodium hypochlorite. These lime deposits and other build ups can clog the fitting increasing the back pressure and interfering with the check valve operation.
- Install the Injection/ Check valve directly into the tee fitting. Do not install the fitting into a pipe stud and then into the tee. The solution must inject directly into the flow stream.
- Use PTFE thread sealing tape on the pipe threads. Push the opaque outlet (discharge) tubing onto the compression barb of the Injection / Check valve fitting. Use the tube nut to secure the tube. Hand tighten only.
- Injection valve should be placed on the main pipe after all pool accessories (heating. Etc.).
- Locate the most suitable point on the pipe, install a ½" female threaded adaptor (reducer tee or service saddle with ½" female thread could be used) at the selected injection point. Please noted that adaptor/ reducer tee/ service saddle are not supplied in the accessories list. Make sure adaptor is well connected.

### 3.1.1 Probe instruction: (DP300-X, DP300-ORP, DP300-PH)

It is essential that the probe holder place on the main pipe after all pool accessories (heating. Etc.) and before injection valve (should be separated to probes minimum 10cm) and cell of salt chlorinator. The holder is designed to install directly into ½" female pipe threads. Probes are required periodic maintenance and calibration.

Locate the most suitable point on the pipe, install a ½" female threaded adaptor (reducer tee or service saddle with ½" female thread could be used) at the selected injection point. Please noted that adaptor/ reducer tee/ service saddle are not supplied in the accessories list. Make sure adaptor is well connected.

Attach the probe holder (by screwing it) in place. To ensure a proper seal, insert a gasket tape, such as Teflon, between the valve and the connector.

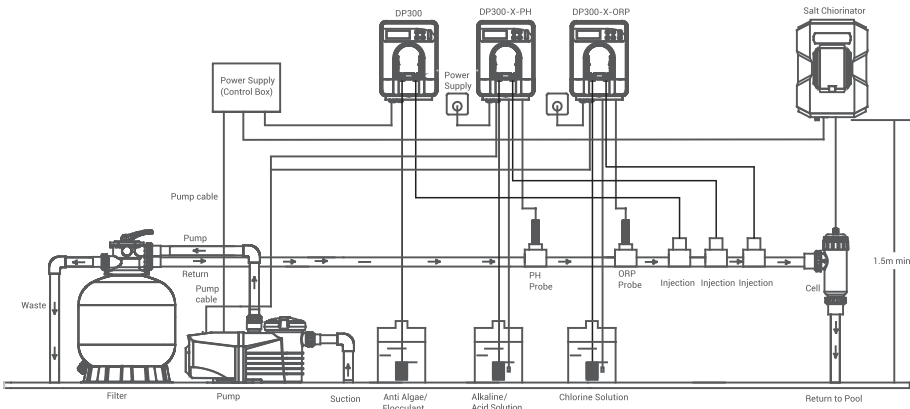

### RECOMMENDED CIRCUIT (BYPASS) FOR INSTALLATION AND MAINTENANCE pH AND RX SENSORS

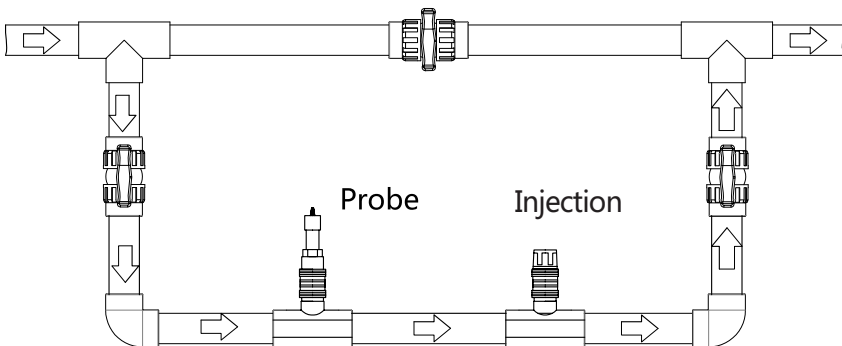

### 3.1.2 Electrical terminals (DP300-X only)

Carefully adhere to the electrical installation regulations in effect within the various countries (Fig. below). If the supply cable lacks a plug, the equipment should be connected to the power mains using a single-pole circuit breaker with a minimum contact gap of 3 mm. Ensure all supply circuits are disconnected before accessing any electrical components.

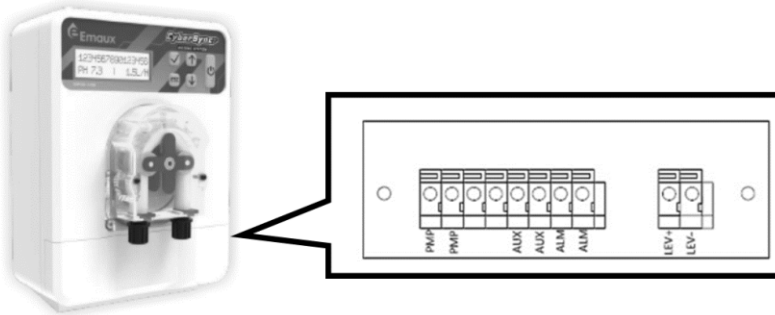

Terminal	Function	Type
1, 2: PMP	Filtration pump detection, when voltage is input, the pump on.	Input: 110V – 240V AC (do not higher than input power to the pump)
5, 6: AUX	Output relay. Powered at input power and it wok in proportional mode by time like the pump	Output: 110V – 240V (same as input power to the pump.) max current output: 500mA.
7, 8: ALM	External Alarm relay. Free contact	Output: <ul style="list-style-type: none"> <li>• Close – Alarm</li> <li>• Open – normal</li> </ul>
9, 10: LEV	Level sensor input	Input (when level sensor function is activated): <ul style="list-style-type: none"> <li>• Open – stop with low level alert</li> <li>• Close - run</li> </ul>

#### Wiring diagram:

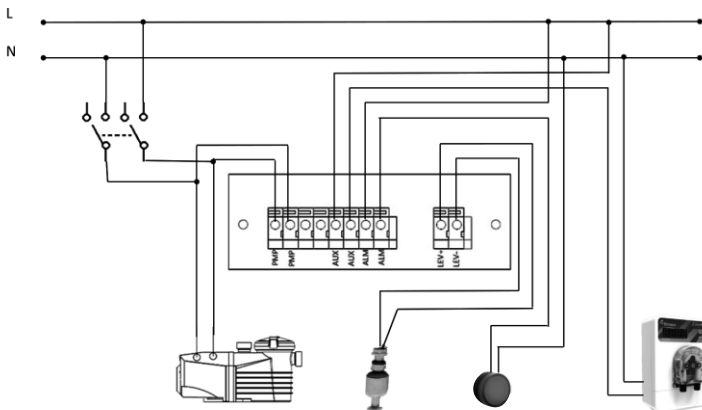



## 3.2 Function and menu

### 3.2.1 Key feature:

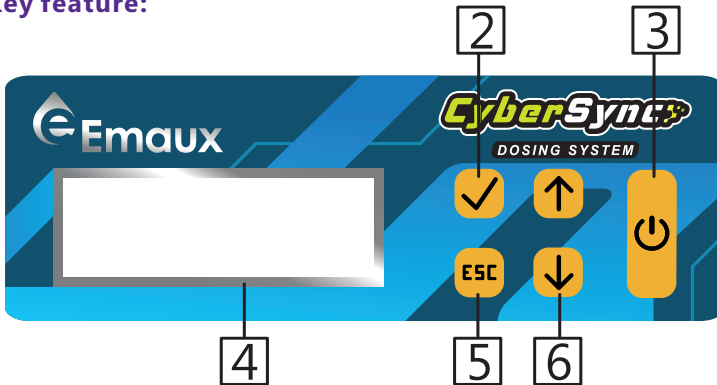

Key	Function	Type
1	Power switch	(rocker switch at the bottom) Power on/ off the pump
2	Menu / confirm	Confirm selection Press and hold to enter Basic menu
3	on / off	Start/ stop the pump function Press and hold to enter Auto threshold setting menu
4	Display	Display and show the status of the pump
5	ESC / cancel	ESC/ cancel selection
6	Up / Down	Up and down selection

#### Remark:

DP300 contains keys on/off, ↑ and ↓ only

Display: DP300-X is matrix LCD; DP300, DP300-ORP, and DP300-PH are segment LED

### 3.2.2 Display

Power up and operating mode

Once the pump is power up, you can see the following information on the screen

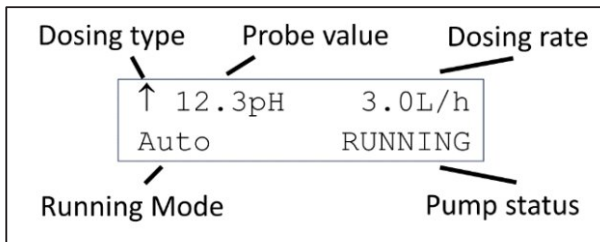

DP300-X operating screen

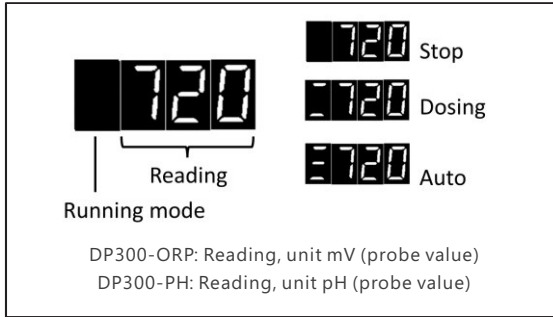

**DP300-ORP/ DP300-PH operating screen**

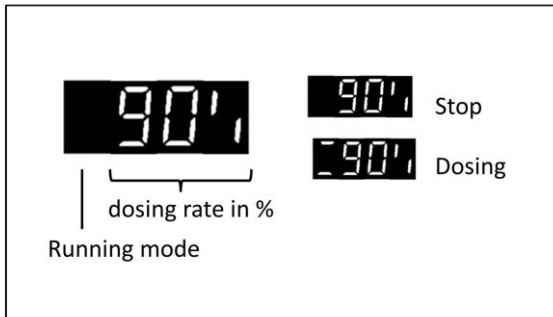

**DP300 operation screen**

**Dosing type:**

When the dosing liquid is dispensed, the probe value will increase.  
 When the dosing liquid is dispensed, the probe value will decrease.

**Probe value:**

Real-time measurement ready by the probe.

**Running Mode:**

Auto: pump is in Auto mode  
 Dosing: pump is in Dosing mode

**Pump status:**

Running: the pump is operating under the mode selected  
 Stop: the pump is stopped  
 Priming: the pump is in priming mode

**Dosing rate:**

Rate that the pump is dosing

### 3.2.3 Probe Calibration

#### DP300-X Probe calibration

Prepare buffer solution: pH 7 and pH 4. Use distilled water to clear the probe before calibrate.

Make sure the correct probe (PH/ ORP) is connected to the pump. Press and hold ESC for 3 seconds to enter to calibration mode (press ESC to exit without saving). Follow instructions on screen to complete the calibration procedure.

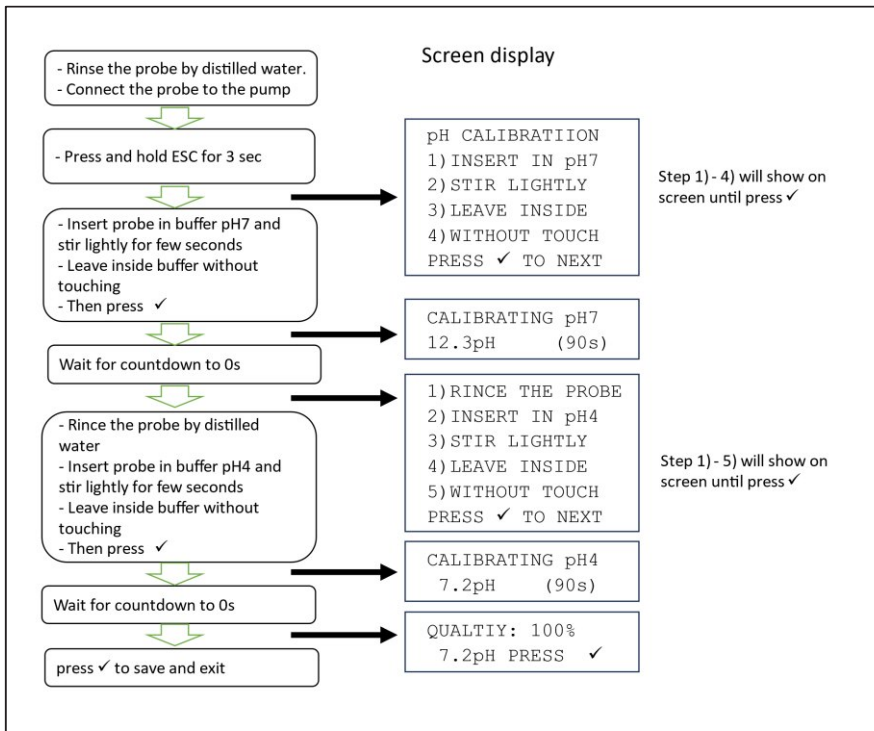

#### PH probe calibration

When QUALITY is the relative life percentage of the probe, below 25%, the probe will be a calibration error, this means that the probe has to be replaced. There will be a calibration error if buffer solution is incorrect.

After calibration, put the probe into pH 10 buffer solution to test alarm concentration error.

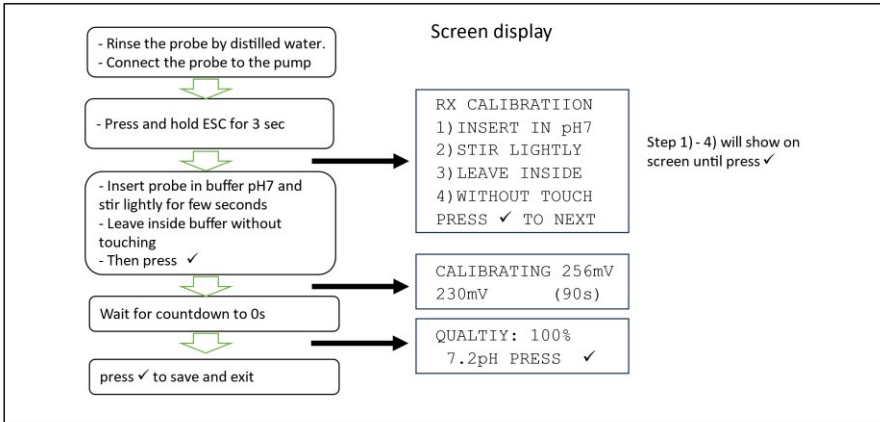

### ORP calibration

### DP300-PH Probe calibration

Prepare buffer solution: pH 7 and pH 4. Use distilled water to clean the probe before calibrate. Make sure the correct pH probe is connected to the pump. Press and hold ESC for 3 seconds to enter to calibration mode (press ESC to exit without saving). Follow instructions on screen to complete the calibration procedure.

After enter to calibration mode:

- 1) " 7.0" will flashes on the screen.
- 2) Insert the probe into the pH 7 buffer solution and wait for at least 90 seconds so to let the probe stable.
- 3) Press " ✓ ", the display will show

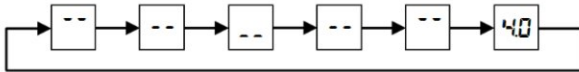

Do not touch the probe until message "4.0" flashes.

(if Er appears, the calibration is failed. Press ESC to exist. Check the probe connect, clean the probe and restart calibration procedure again. If the calibration still fails, change the probe and recalibrate.)

- 4) Use distilled water to clean the probe, then Insert the probe into the pH 4 calibration solution and wait for at least 90 seconds.

- 5) Press " ✓ ", the display will show

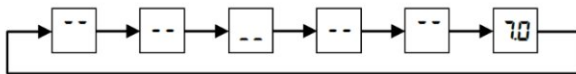

Do not touch the probe until message "done" on the screen, Calibration press is done, press "" to save and exit calibration. (if Er appears, the calibration is failed. Press ESC to exist. Check the probe connect, clean the probe and restart calibration procedure again. If the calibration still fails, change the probe and recalibrate.)

### DP300-ORP Probe calibration

Prepare buffer solution: 256mV. Use distilled water to clean the probe before calibrate.

Make sure the correct ORP probe is connected to the pump. Press and hold ESC for 3 seconds to enter to calibration mode (press ESC to exit without saving). Follow instructions on screen to complete the calibration procedure.

After enter to calibration mode:

- 1) " 256" will flashes on the screen.
- 2) Insert the probe into the 256mV buffer solution and wait for at least 90 seconds so to let the probe stable.
- 3) Press " ✓ ", the display will show

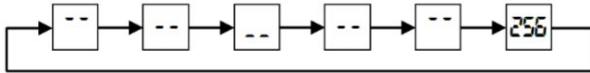

Do not touch the probe until message "done" on the screen, Calibration press is done, press "" to save and exit calibration. (if Er appears, the calibration is failed. Press ESC to exist. Check the probe connect, clean the probe and restart calibration procedure again. If the calibration still fails, change the probe and recalibrate.)

## 3.3 Setup menu

DP300-X, DP300-PH, DP300-ORP has two setup menu for basic and full setup.

### 3.3.1 Basic menu (Automatic mode)

Press and hold ✓ for 3 seconds will enter to basic menu. Basic menu is providing the basic setting for you to quick start the pump. Press ESC any time to exist and go back to operating mode without save.

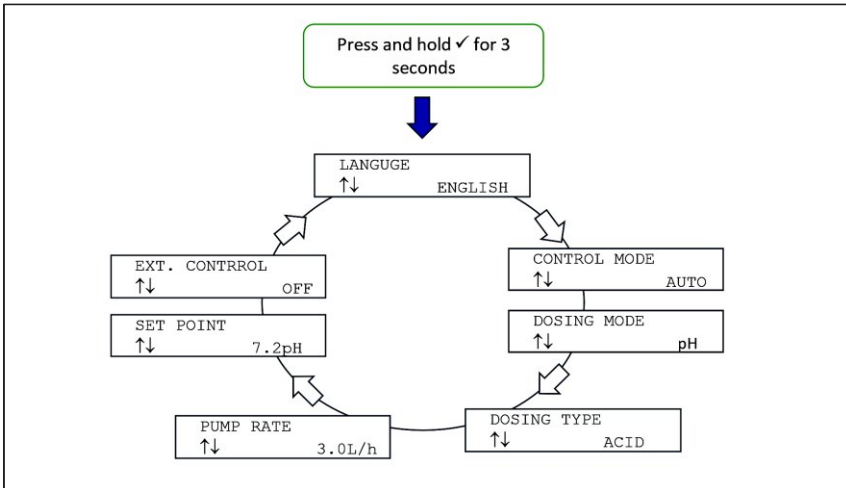

**DP300-X Basic menu**

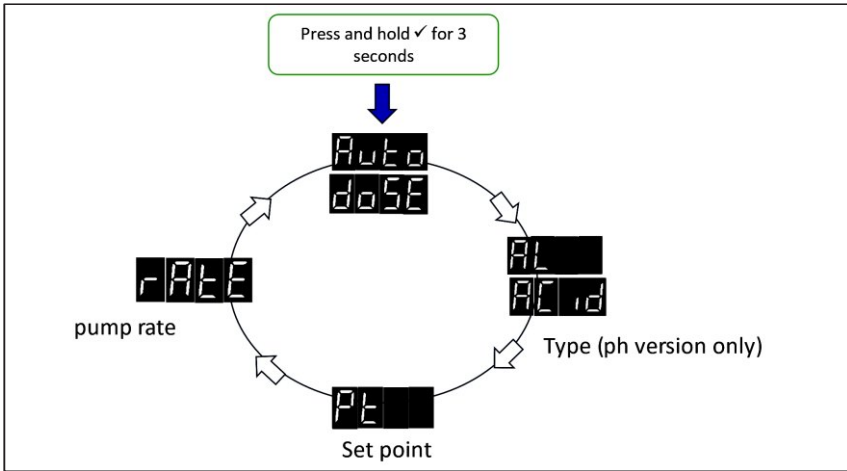

**DP300-ORP/ DP300-PH Basic menu**

### 3.3.2 Full menu

Press and hold ✓ + ↑ for 3 seconds will enter to full menu. Full menu allow for you to setup all functions of DP-X. Press ESC any time to exist and go back to operating mode without save.

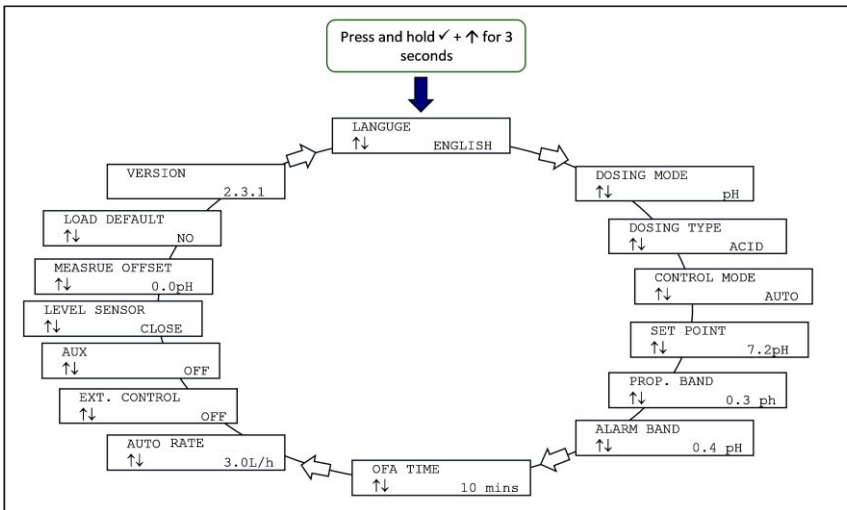

**DP300-X full menu**

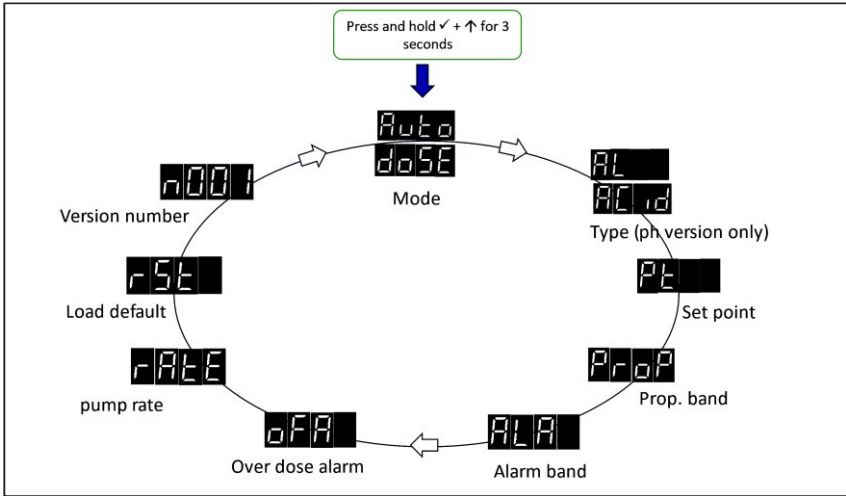

## DP300-ORP/ DP300-PH Basic menu

### LANGUAGE

Language selection on display

### DOSING MODE

To select between pH or ORP, it will change the measurement.

### DOSING TYPE

If dosing mode is PH, the menu is allowed for you to choose either dosing acid or alkaline. In operating mode, arrow on screen will show the type by (alkaline) or (acid).

If dosing mode is ORP, the pump is allowed for oxidant only. The arrow on screen will show (oxidant)

### CONTROL MODE

To select automation or rate dosing mode. AUTO is fully automatic dosing. DOSING is dosing by user setting.

### SET POINT

The threshold points that the target control value.

### PROP. BAND

The pump will reduce dosing rate by proportionally. So to minimize dosing and prevent over dose.

### ALARM BAND

the pump will alarm if value is in alarm band range.

### OFA TIME

Time that Continuous measure out of Alarm band to activate alarm. This can prevent trigger alarm when dosing manually.

## PUMP RATE

User can select pump rate either 1.5L/ hour or 3L/ hour.

## EXT. CONTROL

Allows the enabling/ disabling of the external control though voltage input corresponding to the enabling of the filtration pump. It is the input that corresponds to electrical terminals PMP (filtration pump connection).

## AUX

To enable the AUX control function. It is electrical terminals AUX control.

## LEVEL SENSOR

To enable LEVEL SENSOR function, user can select different type of level probe: open type or close type. Emaux level probe is close operation type. It is electrical terminals LEV control.

## MEASURE OFFSET

Adjustment of the displayed value offset, Use to compensate offset of PH or REDOX probe reading. Caution: improper use of this parameter may result in erroneous dosing.

## LOAD DEFAULT

Load the default setting for the pump

## VERSION

Pump software version

Function	Options	Default
LANGANGE	English, Francais, Espanol, Deutsh, Portuges	English
DOSING MODE	pH, ORP	ORP
DOSING TYPE	pH: ACID, ALKALINE; ORP: OXIDANT	pH: ACID; ORP:OCIDANT
CONTROL MODE	AUTO, DOSING	AUTO
SET POINT	pH: 6.0 – 9.0; ORP: 650mV-900mV	pH: 7.2; ORP: 740mV
PROP. BAND	pH: 0.0 – 2.0; ORP: 0-200 mV, 0 disable	pH: 0.5; ORP: 100mV
ALARM BAND	pH: 0.0 – 4.0; ORP: 0-1000 mV	pH: 2.0; ORP: 300mV
OFA TIME	0-60 minutes	20 minutes
PUMP RATE	3.0L/hour, 1.5L/hour	3L/hour
EXT. CONTROL	ON, OFF	OFF
AUX	ON, OFF	OFF
LEVEL SENSOR	CLOSE, OPEN, OFF	CLOSE
MEASURE OFFSET	pH: -1 to +1 (0.1 PH/ step); ORP: -100 to +100mV (10mV/step)	pH: 0; ORP: 0mV
LOAD DEFAULT	YES, NO	NO

## Memory retainion

The pump will save the pervious stage before power off. User does not need to set the pump after power down.



### 3.4 Operation

Model	Power up delay	Priming	Auto	Dosing
DP300-X	✓	✓	✓	✓
DP300-ORP	✓	✓	✓	✓
DP300-PH	✓	✓	✓	✓
DP300	X	X	X	✓

#### 3.4.1 Power up delay

During power up, the pump will delay to dosing 90 sec for probe system stable before start dosing. Screen will show WAIT on screen.

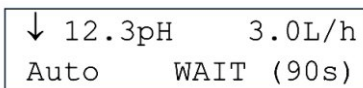

↓ 12.3pH      3.0L/h  
Auto      WAIT (90s)

**DP300-X**



90

**DP300-ORP/ DP300-PH**

#### 3.4.2 Priming

During the pump at STOP, user can press and hold ✓+↑ for priming. Dosing rate would be maximum of the pump. (when AUX function is enabled, AUX will be turn on with priming)

#### 3.4.3 Auto mode

In auto mode, the pump will dosing by proportional dosing, The dosing rate decrease progressively as it approaches the setpoint. Proportional control is particularly useful to avoid overdosing in small pool.

Set-point type: acid

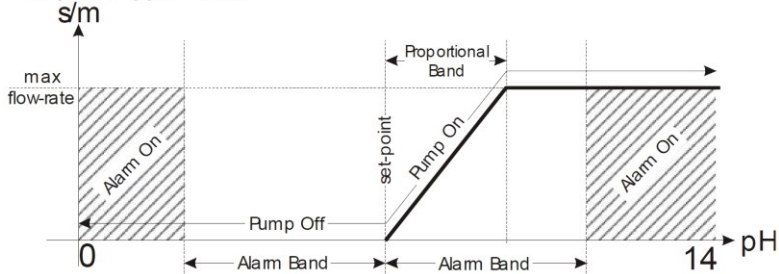

Set-point type: alkaline

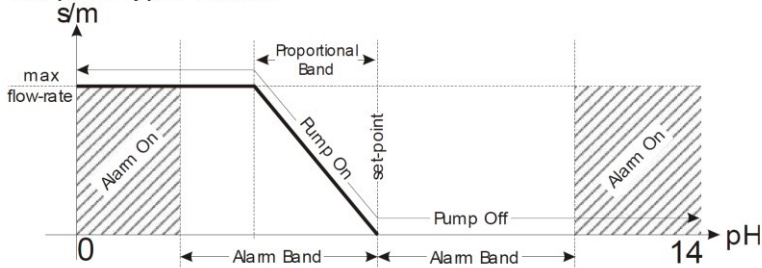

Set-point type: oxidant

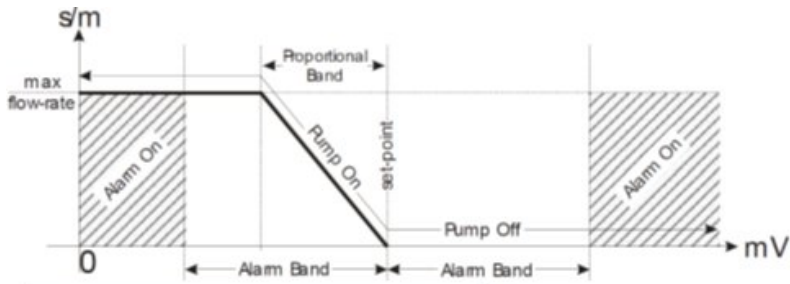

Set the dosing pump to Auto mode, then follow the procedure to setup:

- 1) Adjust parameters to control auto mode: Dosing type, Setpoint, proportional band and alarm band.
- 2) Run the recirculation pump with both sensor in line at least 30 minutes to stabilize the sensor readings.
- 3) After 30 minutes, test the pH/ORP of the water, adjust the proportional band or setpoint if necessary.
  - a. Setpoint is to adjust the offset of dosing.
  - b. Proportional band can adjust dosing rate. Increase proportional band will reduce the dosing rate.

### 3.4.4 Dosing mode

Set the dosing pump to dosing mode, then following the procedure to setup:

1. Calculation the required dosing rate for your application.
2. Press power to switch the pump to run for an hour,
3. Stop the pump and check the parameter change whether same as your expected, adjust the dosing rate if necessary.

In Dosing mode, the dosing rate of the pump is controlled by the duty cycle. You can adjust the dosing rate by % of PUMP RATE.

- When PUMP RATE is 3.0L/hour, 80% of PUMP RATE is 2.4L/hour.
  - When PUMP RATE is 1.5L/hour, 20% of PUMP RATE is 300mL/hour.
- (DP300 working at 3.0L/hr only)

Change dosing rate

- During in Dosing mode, press  $\uparrow$  or  $\downarrow$  can change dosing rate. If the dosing is "Stop", pump will run the updated dosing rate once start pump function. Otherwise, the pump will stop 15 seconds then run the updated dosing rate.

DP300-X

- In Dosing mode, dosing rate in % will show on the screen. Dosing rate can be change by press  $\uparrow$  or  $\downarrow$ .

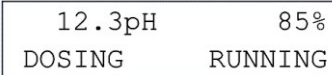

12.3pH	85%
DOSING	RUNNING

DP300-X Dosing mode screen

DP300-PRP/ DP300-PH

- In Dosing mode, press  $\uparrow$  or  $\downarrow$ , screen will switch to display dosing rate. Dosing rate can be change by press  $\uparrow$  or  $\downarrow$ . Press  $\checkmark$ , ESC or without key press for 5 seconds to exist the dosing rate screen and display pH/ ORP.



DP300 Dosing mode screen, 90%

DP300

- Dosing rate can be change by press  $\uparrow$  or  $\downarrow$ .

### 3.5 General Maintenance

Check the chemical solution in the tank periodically to avoid the peristaltic pump from running dry. Even if this were to happen, no damage will occur to the pump. The level control sensor provided as a standard accessory will stop the pump in case of a low chemical level in the tank. However, it is still advisable to perform a systematic check to avoid a lack of chemical in the system.

To check for any tears or wear, inspect the pump hose every three months. Additionally, perform a periodic cleaning of the foot filter (DP300-X only) and injection valve (see next point). It is also advisable to check the status of screws and seals every three months or at the end of the season. The use of very aggressive or solid suspended chemicals may require more frequent inspections.

As mentioned earlier, the wetted parts should be maintained periodically using the most appropriate cleaning reagent. Considering the large number of chemicals available on the market, it is not possible to provide a general recommendation.

To test the sensors while they are installed, carefully add a small amount of white vinegar or dilute acid solution into the skimmer. After a few minutes:

The PH reading should decrease.

The ORP (Oxidation Reduction Potential) reading should increase.

If you do not observe any response or the response is slow, clean or replace the sensors as soon as possible.

#### (Hose Kit) Tube Maintenance

- Material Inspection: Regularly check (recommended monthly) the tubing for signs of wear, cracks, or discoloration. Replace if damaged.
- Proper Installation: Ensure the tubing is correctly installed without kinks or bends that could impede flow.
- Handling deformed/ aging: If the tubing has deformed/ aging, gently straighten it. Apply a suitable lubricant (such as Vaseline) regularly (recommended monthly) to help ease the process and minimize further deformation. Replace the tube if necessary.
- Flow Monitoring: Regularly monitor flow rates. A decrease in flow may indicate tubing deformation, aging or blockages.
- Cleaning: Clean the tubing periodically to prevent buildup of residues.
- Chemical Compatibility: Ensure the tubing material is compatible with the chemicals being dosed to avoid degradation.
- Regular Replacement: Establish a routine replacement schedule based on usage.
- Check Connections: Regularly inspect the connections to ensure they are secure and leak-free.
- Lubrication: Apply a suitable lubricant (such as Vaseline) to the tubing during installation and maintenance to facilitate easier handling and reduce wear.
- Tubing life: Utilized operating at 600RPM under room temperature (23°C) tubing life is 1000 hrs at 0 or 10 psi back pressure. The performance of tubing in peristaltic pumping applications is affected by the conditions of use and the equipment utilized. The tubing life is presented for information only and should not be utilized for specification purposes

#### ORP AND PH SENSOR CLEANING

The sensor tips must be kept clean and free from chemical deposits and contamination to function properly. Depending on the water quality and other facility-specific characteristics, the sensors may need to be cleaned on a weekly or monthly basis after being saturated in pool or spa water. Slow response and inconsistent readings are signs that the sensors require cleaning.

To clean a sensor, carefully remove it from the compression fitting. Clean the tip of the sensor with a mild liquid detergent (such as Joy) solution. Rinse with fresh water and soak the sensor in a mild acid solution for five minutes. Rinse with fresh water and reinstall the sensor.

#### SENSOR REPLACEMENT

For optimum controller performance, always use Emaux replacement sensors. For preventive maintenance, it is also recommended to replace the sensors on an annual basis or as their performance diminishes.

#### SENSOR STORAGE

Extended exposure to atmospheric conditions will cause the ORP and pH sensor tips to dry out.

Always remove and properly store the sensors if the pool or spa is to be winterized or inactive. Store the sensors with the original cap provided, making sure that each cap is filled with the original storage solution or salt water. If the storage containers have been misplaced, store the sensors individually in small glass or plastic containers with clean water covering the sensor tips.

#### WINTERIZING

The sensors should be prepared for storage as outlined above and protected from freezing. Although the controller is designed to withstand a broad temperature range, winter storage in a secure location at normal room temperature is recommended.

## 4. TROUBLESHOOTING

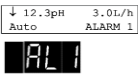
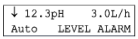
Issue	POSSIBLE CAUSE	SOLUTION
<b>Tubing but additive is not being injected</b>	<ol style="list-style-type: none"> <li>1. Tubing is swollen</li> <li>2. Tube is blocked</li> <li>3. Valve is blocked</li> </ol>	<ol style="list-style-type: none"> <li>1. Check the integrity of the peristaltic pump tubing</li> <li>2. Check for clogging of the filter</li> <li>3. Verify that the injection valve is not blocked</li> </ol>
<b>Measure is not correct</b>	<ol style="list-style-type: none"> <li>1. Calibration is incorrect</li> <li>2. Probe not function properly</li> </ol>	<ol style="list-style-type: none"> <li>1. Check the probe position to make sure fully in water.</li> <li>2. Run calibration the probe</li> <li>3. If measurement is incorrect, replace a new probe</li> </ol>
<b>The pump is not turn on</b>	No power	<ol style="list-style-type: none"> <li>1. Check the circuit breaker. Connected to functional grounding-type GFCI protected power source</li> <li>2. Check internal fuse</li> <li>3. Power switch on the bottom is on.</li> </ol>
<b>No checkical dosing</b>	Auto mode: setup is incorrect	<ol style="list-style-type: none"> <li>1. Check setpoint and measure value.</li> <li>2. Check dosing type</li> </ol>
<b>ALARM 1/ AL1</b> (DP300-X, DP300-ORP, DP300-PH ) 	Alarm band alarm trigger	<ol style="list-style-type: none"> <li>1. Water quality: Check water quality</li> <li>2. Over dose: check dosing/ manual dosing, type whether is correct or not</li> <li>3. Incorrect dose: check setting for Auto dosing: setpoint, proportional band and alarm band.</li> <li>4. Probe failure: recalculate/ clean the probe. If the probe reading keeps incorrect, replace a new probe.</li> </ol>
<b>ALARM 2/ AL2</b> (DP300-X, DP300-ORP, DP300-PH)	Probe reading no change for dose 20 minutes	<ol style="list-style-type: none"> <li>1. Dosing tank empty: refill the dosing tank</li> <li>2. Dosing tube broken: replace tubes</li> <li>3. Dosing tube blocked: clean/ replace tubes</li> </ol>
<b>ALARM 3/ AL3</b> (DP300-X, DP300-ORP, DP300-PH)	Dosing reading violate dosing type. e.g. dosing acid, pH value should reduce, but the reading violate which increase.	<ol style="list-style-type: none"> <li>1. Incorrect dosing type: check dosing type in the dosing tank.</li> <li>2. Dosing type incorrect: input the correct dosing type in menu.</li> </ol>
<b>ALARM 4/ AL4</b>	Motor failure	<ol style="list-style-type: none"> <li>1. Tube jam: clean tubes</li> <li>2. Motor failure: replace a new motor</li> </ol>
<b>LEVEL ALARM</b> (DP300-X only) 	Level probe shows low	<ol style="list-style-type: none"> <li>1. Level sensor setting incorrect: make sure the setting matches the type of level sensor.</li> <li>2. Tank is empty: refill the tank</li> <li>3. Level probe failure: check the probe and probe connection. If the probe is out of function, replace a new probe.</li> </ol>

## 5. SPARE PARTS LIST

### DP300-X

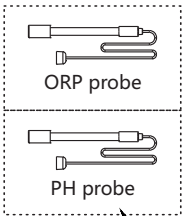
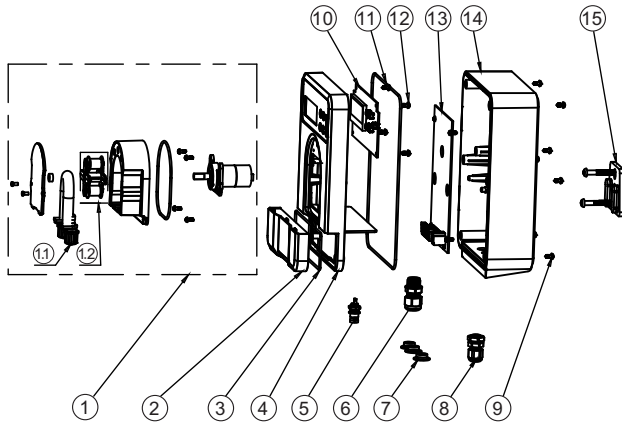

16



17

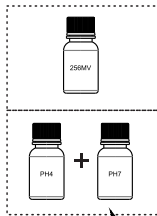

18



19



20

Key No.	Part No.	Description	Piece(s) Required
1	E130101	Pump body kit	1
1.1	E130102	Hose kit	1
1.2	E130103	Drive bracket kit	1
2	4205916005	Wiring cover for DP	1
3	5100510338	Face cover for DP	1
4	111040097	O-Ring for Wiring cover	1
5	1062610401	BNC connect	1
6	106234778	Cable lock code PGB9	1
7	111040100	plug D19x9.6x6	4
8	106234332	Cable lock code PGB7	1
9	112232743	Screw M3X8	11
10	104130033	Button electronic board for PRO	1
11	111040099	O-Ring for cover	1
12	104130038	Screw M2.2X8	9
13	104130038	Control electronic board for ORP	1
	104130042	Control electronic board for pH	1
14	5100410338	box	1
15	540200008	Wall mount holder with screw	1
16	106090074	ORP probe	1
	106090073	pH probe	1
17	106090075	Probe holder	1
18	1090010392	256 buffer solution for ORP	1
	109007168	pH4.0 and pH 7.0 ,30 ml for pH	1
19	E130104	Dosing pipe fitting	1
20	104130040	water level switch	1

# DP300-ORP

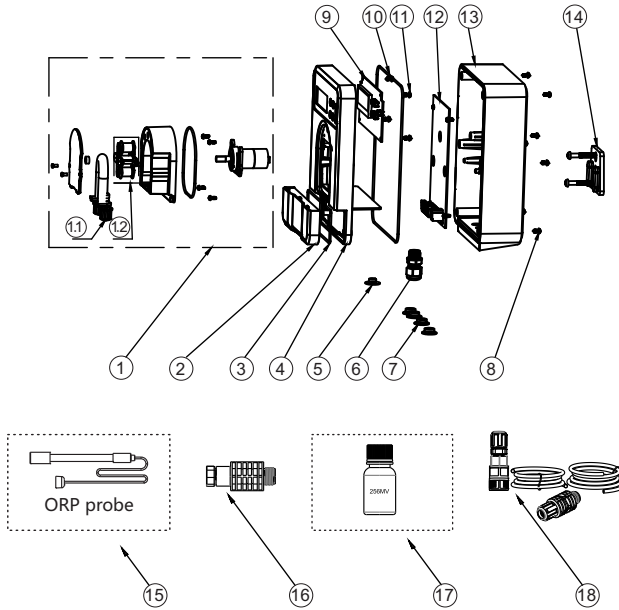

Key No.	Part No.	Description	Piece(s) Required
1	E130101	Pump body kit	1
1.1	E130102	Hose kit	1
1.2	E130103	Drive bracket kit	1
2	4205916005	Wiring cover for DP	1
3	5100510338	Face cover for DP	1
4	111040097	O-Ring for Wiring cover	1
5	1062610401	BNC connect	1
6	106234778	Cable lock code PGB9	1
7	111040100	plug	4
8	112232743	Screw M3X8	11
9	104130041	Button electronic board for Plus	1
10	111040099	O-Ring for cover	1
11	104130038	Screw M2.2X8	9
12	104130043	Control electronic board for Plus	1
13	5100410338	box	1
14	540200008	Wall mount holder with screw	1
15	106090074	ORP probe	1
16	106090075	Probe holder	1
17	1090010392	256 buffer solution for ORP	1
18	E130104	Dosing pipe fitting	1



# DP300-PH

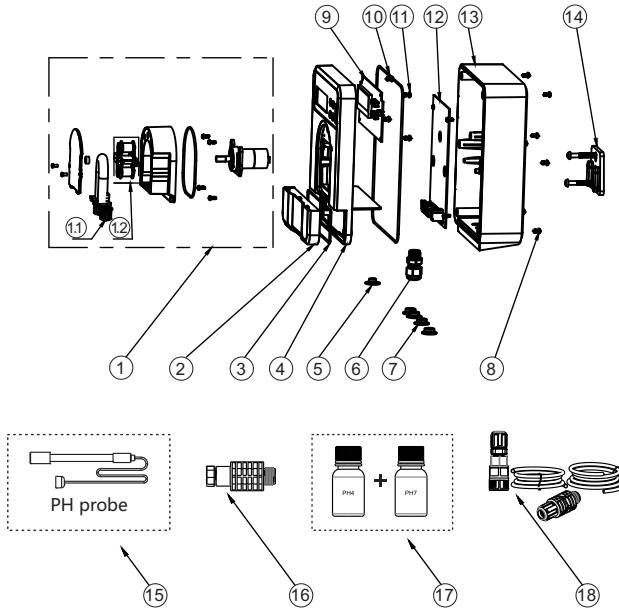

Key No.	Part No.	Description	Piece(s) Required
1	E130101	Pump body kit	1
1.1	E130102	Hose kit	1
1.2	E130103	Drive bracket kit	1
2	4205916005	Wiring cover for DP	1
3	5100510338	Face cover for DP	1
4	111040097	O-Ring for Wiring cover	1
5	1062610401	BNC connect	1
6	106234778	Cable lock code PGB9	1
7	111040100	plug	4
8	112232743	Screw M3X8	11
9	104130041	Button electronic board for Plus	1
10	111040099	O-Ring for cover	1
11	104130038	Screw M2.2X8	9
12	104130044	Control electronic board for DP300-PH	1
13	5100410338	box	1
14	540200008	Wall mount holder with screw	1
15	106090073	pH probe	1
16	106090075	Probe holder	1
17	109007168	pH4.0 and pH 7.0, 30 ml for PH	1
18	E130104	Dosing pipe fitting	1

# DP300

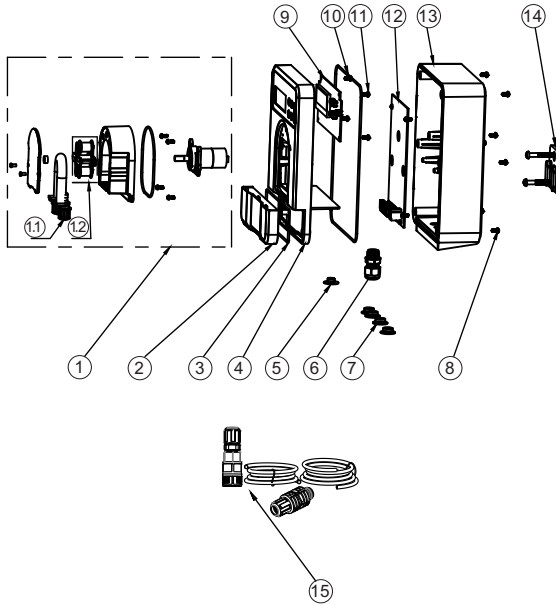

Key No.	Part No.	Description	Piece(s) Required
1	E130101	Pump body kit	1
1.1	E130102	Hose kit	1
1.2	E130103	Drive bracket kit	1
2	4205916005	Wiring cover for DP	1
3	5100510338	Face cover for DP	1
4	111040097	O-Ring for Wiring cover	1
5	111040102	O-Ring for BNC	1
6	106234778	Cable lock code PGB9	1
7	111040100	plug	4
8	112232743	Screw M3X8	11
9	104130041	Button electronic board for Plus	1
10	111040099	O-Ring for cover	1
11	104130038	Screw M2.2X8	9
12	104130045	Control electronic board for DP300	1
13	5100410338	box	1
14	540200008	Wall mount holder with screw	1
15	E130104	Dosing pipe fitting	1

---

## 6. TERMS OF THE WARRANTY

---

As original purchaser of this equipment have purchased from Emaux Water Technology Co Ltd, through Authorized International Distributor or Dealer, warrants its products free from defects in materials and workmanship under normal use during warranty period. The warranty period begins on the day of purchase and extends only to the original purchaser. It is not transferable to anyone who subsequently purchases the product from you. It excludes all expendable parts. During the warranty period, Emaux authorized reseller will repair or replace defective parts with new parts or, at the option of Emaux, serviceable used parts that are equivalent or superior to new parts in performance. This Limited Warranty extends only to products purchased from Emaux authorized reseller. This Limited Warranty does not extend to any product that has been damaged or rendered defective

- (a) as a result of accident, misuse or abuse;
- (b) as a result of an act of God;
- (c) by operation outside the usage parameters stated herein;
- (d) by the use of parts not manufactured or sold by Emaux;
- (e) by modification of the product;
- (f) as a result of war or terrorist attack; or
- (g) as a result of service by anyone other than Emaux authorized reseller or authorized agent.

EXCEPT AS EXPRESSLY SET FORTH IN THIS WARRANTY, EMAUX MAKES NO OTHER WARRANTIES EXPRESSED OR IMPLIED, INCLUDING ANY IMPLIED WARRANTIES OR MERCHANTABILITY AND FITNESS FOR A PARTICULAR PURPOSE. EMAUX EXPRESSLY DISCLAIMS ALL WARRANTIES NOT STATED IN THIS LIMITED WARRANTY. ANY IMPLIED WARRANTIES THAT MAY BE IMPOSED BY LAW ARE LIMITED TO THE TERMS OF THIS EXPRESS LIMITED WARRANTY.

## **EMAUX WATER TECHNOLOGY CO., LTD**

**ADDRESS: 2/F, Lockhart Centre, No. 301-307 Lockhart Road,  
Wanchai, Hong Kong**

**PHONE +852 2832 9880**

 **YOUR PREMIER SUPPLIER**

**[www.emauxgroup.com](http://www.emauxgroup.com)**