

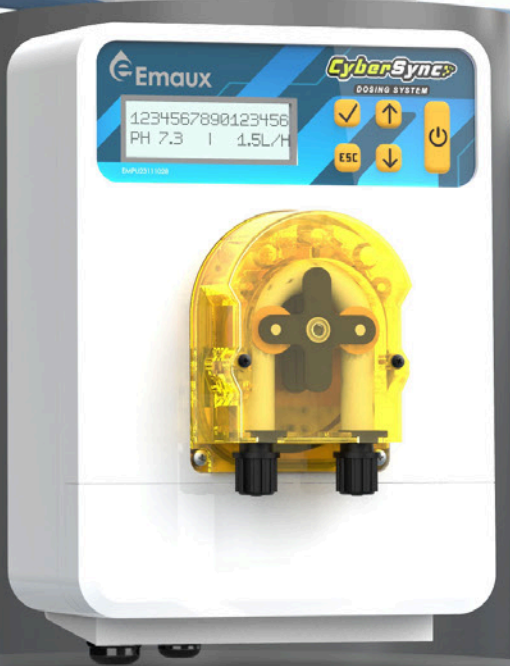

PRECISE, RELIABLE AND VERSATILE FLUID HANDLING

For measurement of the PH, Redox / ORP value

CyberSync[®] Dosing System



ACCURATE AND RELIABLE

The Emaux "CyberSync" Peristaltic Dosing Pump series is indeed a groundbreaking addition to pool maintenance technology. Designed for swimming pools ranging from 30m² to 150m², it offers three versions: Core-Pro, Core-Plus, and Core, with five different models to cater to various needs. Utilizing peristaltic technology, these pumps ensure precise and reliable dosing, keeping pools balanced and sanitized. The user-friendly control panel, chemical-resistant BTP tube, and durable shield enhance its dependability. Additionally, its wide voltage range (110V to 240V) simplifies installation across different electrical systems, making it an excellent choice for maintaining a crystal-clear pool.

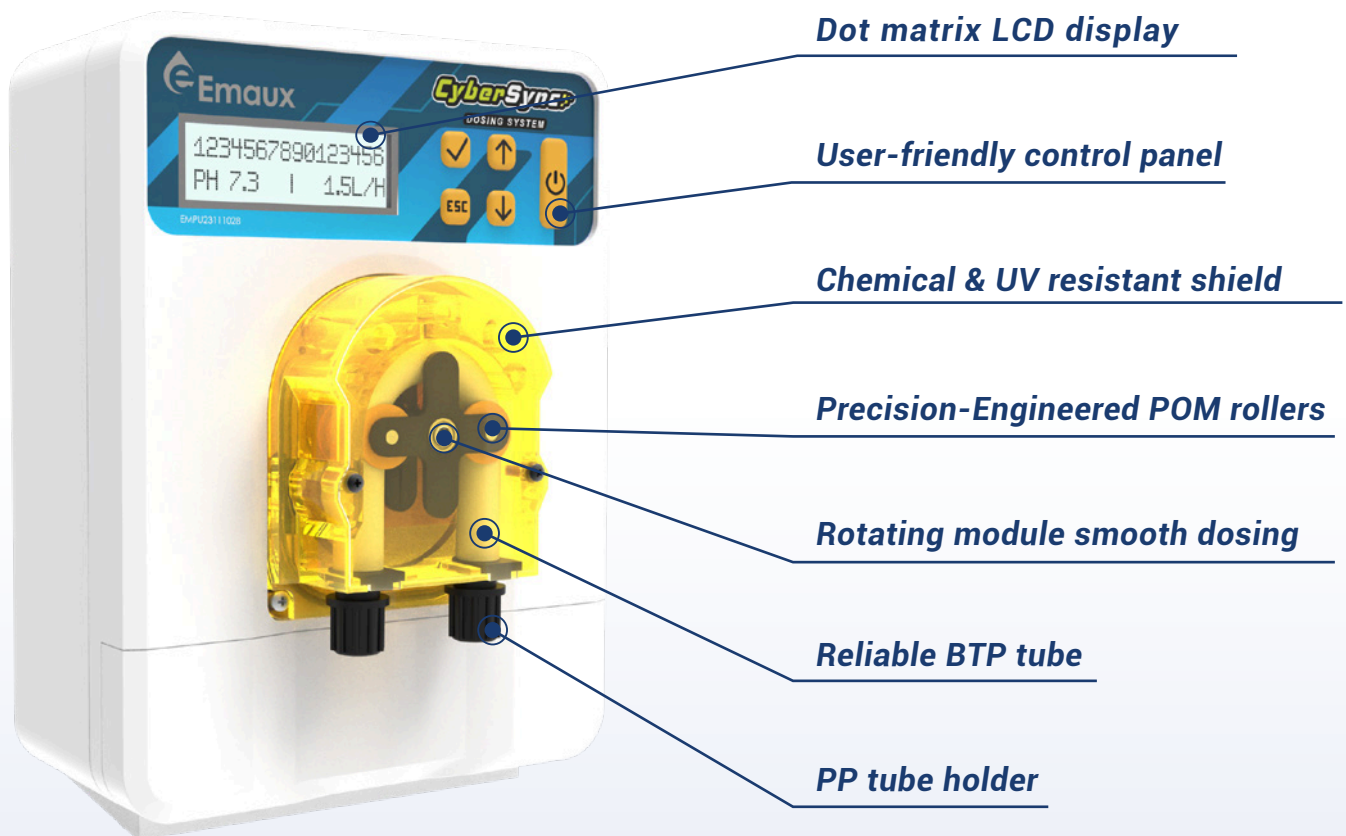

CE CB SAA   IPX4 

Technical Overview:

Chemical Concentration:

Liquid Chlorine up to 30%

Muriatic acid up to 40%

Operating Voltage: 110-240V 50/60Hz

Max Dosing Rate: 3 L/hour

Consumption: 20 watt

Pressure: 1.5 bar [22 psi]

Strainer / injector Tube Size: 4 x 6 (mm) tube

Core-Pro Version



The Emaux CyberSync Core-Pro is an advanced peristaltic dosing pump designed for seamless automatic dosing. It integrates with Emaux pH or ORP probes, ensuring precise and comprehensive dosing automation. Additionally, it supports external connectivity for pump control, level probes, alarms, and other dosing pumps, offering a straightforward and complete automation solution for various dosing requirements. This makes it an excellent choice for maintaining optimal water quality with minimal manual intervention.



Model:	DP300-X
Display:	LED (Dot Matrix)
Depoly Probe:	ORP or pH
External connection*:	Pump, Alarm, Level sensor

*Max power for external dosing pump: 50w

Code	Model	Pressure bar [psi]	Max dosing rate L/hour	Measurable range	Operating voltage v	Input power w
9130113	DP300-X-ORP	1.5 [22]	3	ORP: 300 to 900mV	110-240	20
9130117	DP300-X-PH	1.5 [22]	3	pH4 - pH10	110-240	20



Core Version

Model: DP300

Display: LED

The Emaux CyberSync Core is indeed a versatile dosing solution designed for ease of use. It allows users to effortlessly adjust the dosing rate, ensuring precise control over chemical levels.

Code	Model	Pressure bar [psi]	Max dosing rate L/hour	Operating voltage v	Input power w
9130116	DP300	1.5 [22]	3	110-240	20

Core-Plus Version

The Emaux CyberSync Core-Plus is a fantastic solution for maintaining optimal pool chemistry! Its automatic dosing feature for ORP and pH control, along with the user-friendly LED display, makes it easy to monitor and adjust water quality in real-time. Whether you choose the ORP or pH version, this device ensures that your pool remains in perfect balance, providing a hassle-free experience for pool owners.



Model: DP300-ORP
Display: LED
Probe: ORP



Model: DP300-PH
Display: LED
Probe: pH

Code	Model	Pressure bar [psi]	Max dosing rate L/hour	Measurable range	Operating voltage v	Input power w
9130114	DP300-ORP	1.5 [22]	3	ORP: 300 to 900mV	110-240	20
9130115	DP300-PH	1.5 [22]	3	pH4 - pH10	110-240	20



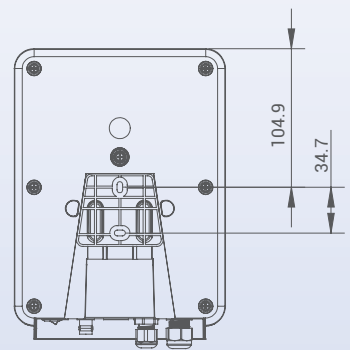
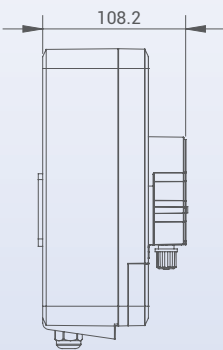
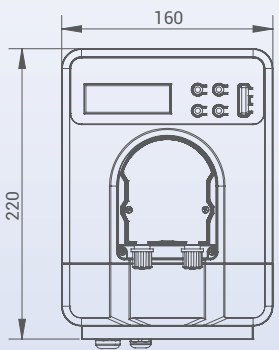



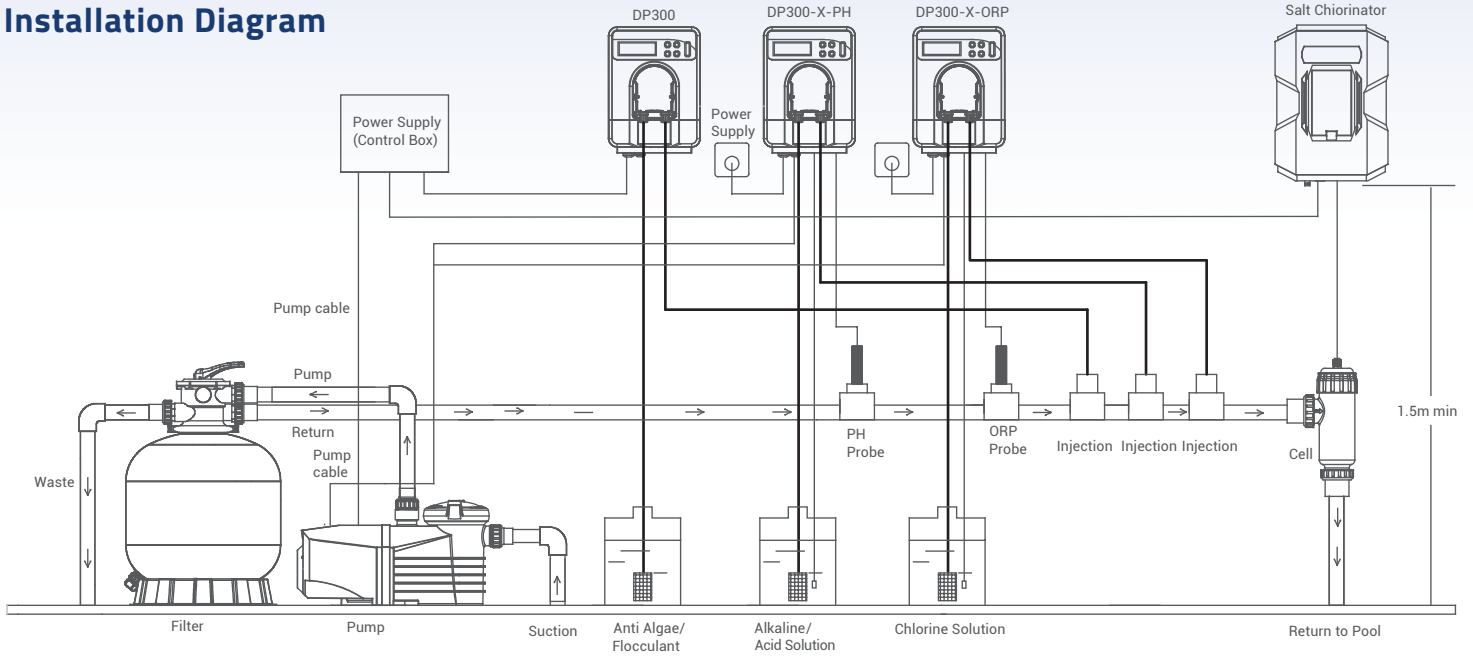

Product Dimensions



Installation Diagram



Probe and Accessories Specifications

Code	Product Name	Parameter	Photo	DP300-X-ORP	DP300-X-PH	DP300-ORP	DP300-PH	DP300
50932003	ORP probe	Pressure: 7 bar Material: epoxy Measuring range: -300 to 900mV (with 3m signal line) Electrode diameter: 12mm		✓	✗	✓	✗	✗
50932002	pH probe	Pressure: 7 bar Material: epoxy Measuring range: 0- 14 (with 3M signal line) Electrode body diameter: 12mm		✗	✓	✗	✓	✗
50932004	Probe holder	½" male thread		✓	✓	✓	✓	✗
51301007	256 buffer solution	256mV, 30mL		✓	✗	✓	✗	✗
51301011	pH probe buffer solution pH4 and pH7	pH 4.0 and pH 7.0, 30mL		✗	✓	✗	✓	✗
41501023	Dosing pipe fitting	Pressure: 7 bar PE Tube: 4x6 tube x 1 pc PVC Tube: 4x6 tube x 1 pc PVDF Injector: ½" male thread x 1 pc PVDF strainer: with valve x 1 pc		✓	✓	✓	✓	✓
50903036	Level probe	With 2m signal line		✓	✓	✗	✗	✗
11303006	Wall mount holder	With screw		✓	✓	✓	✓	✓
534280	25L Dosing tank (Optional item)	Size: 320 X 200 X 390mm		✗	✗	✗	✗	✗

CyberSync[®]

**PRECISE, RELIABLE AND
VERSATILE FLUID HANDLING**

FOR MEASUREMENT OF THE PH, REDOX / ORP VALUE



Core-Pro Version

Core Version

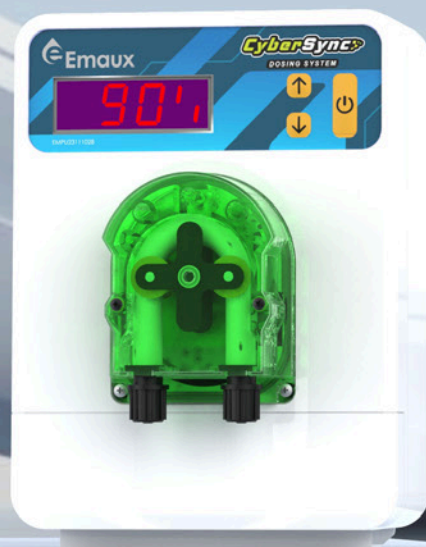

Product features:

- Easy installation and maintenance
- User-friendly interface and operation
- Precise and reliable pool chemical control
- Versatile model option
- Adjustable flow rate control

Core-Plus pH Version

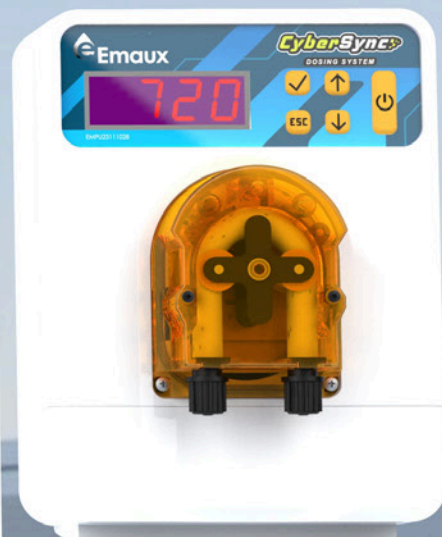

**Core-Plus
ORP Version**



EMAUX WATER TECHNOLOGY CO., LTD

ADDRESS: 2/F, Lockhart Centre, No. 301-307 Lockhart Road,
Wanchai, Hong Kong
PHONE +852 2832 9880
www.emauxgroup.com

 **YOUR PREMIER SUPPLIER**