

Pool Surrounding Equipment

DURABLE FOR ALL WEATHER CONDITIONS

Resistant to pool chemicals and sunlight



Material

Reinforced ABS for strength
and longevity of use

 **Emaux**
water technology

Pool & Spa Equipment

www.emauxgroup.com

Inlet Fittings

RETURN INLET

RETURN INLET

Return Inlet (EM4408)

1. For concrete pool
2. Adjustable angle

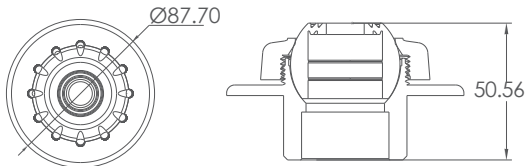

Code	Model	Connection	Flow Rate (L/min)
91601211	EM4408(A)	1"/1.5" Class 12 Solvent	50/150
91601234	EM4408(A1)	1"/1.5" Class 15 Solvent	50/150
91601212	EM4408(E)	32mm/50mm PN10 Solvent	50/150
91601235	EM4408(E1)	32mm/50mm PN16 Solvent	50/150

Return Inlet (EM4409)

1. For concrete pool
2. Adjustable angle

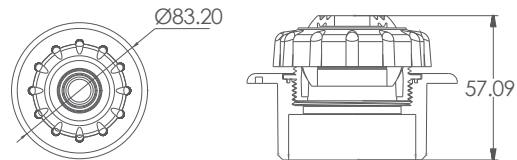

Code	Model	Connection	Flow Rate (L/min)
91601213	EM4409(A)	1.5"/2" Class 12 Solvent	150/240
91601236	EM4409(A1)	2" Class 15 Solvent	150/240
91601214	EM4409(E)	50mm/63mm PN10 Solvent	150/240
91601237	EM4409(E1)	63mm PN16 Solvent	150/240

Return Inlet (EM4412)

1. For vinyl pool
2. Recommended wall conduit EM2842
3. Adjustable angle

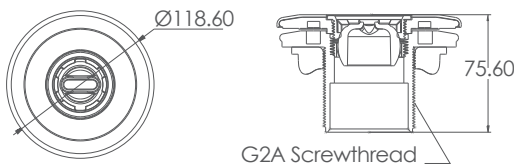

Code	Model	Connection	Brass Inserts	Flow Rate (L/min)
91601219	EM4412(A)	1.5" Solvent, G2A Screwthread	Yes	150
91601220	EM4412(E)	50mm Solvent, G2A Screwthread	Yes	150
91601227	EM4412A TS	1.5" Solvent, G2A Screwthread	No	150
91601228	EM4412E TS	50mm Solvent, G2A Screwthread	No	150

Return Inlet (EM4413)

1. For concrete pool
2. Adjustable angle

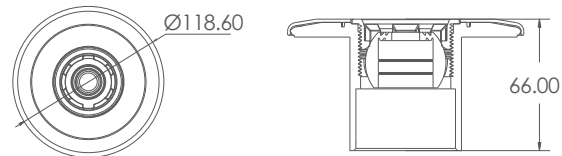

Code	Model	Connection	Flow Rate (L/min)
91601221	EM4413(A)	1.5"/2" Class 12 Solvent	150
91601238	EM4413(A1)	2" Class 15 Solvent	150
91601222	EM4413(E)	50mm/63mm PN10 Solvent	150
91601239	EM4413(E1)	63mm PN16 Solvent	150

Return Inlet (EM4410)

1. For concrete pool
2. Recommended wall conduit EM2841/EM2842
3. Adjustable angle

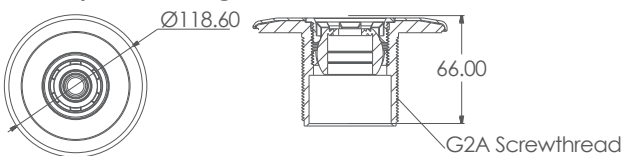

Code	Model	Connection	Flow Rate (L/min)
91601215	EM4410(A)	1.5" Solvent, G2A Screwthread	150
91601216	EM4410(E)	50mm Solvent, G2A Screwthread	150

Return Inlet (EM4411)

1. For concrete pool
2. Recommended wall conduit EM2841/EM2842
3. Adjustable angle

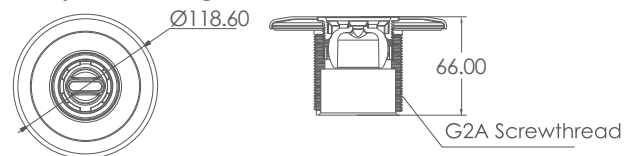

Code	Model	Connection	Flow Rate (L/min)
91601217	EM4411(A)	1.5" Solvent, G2A Screwthread	150
91601218	EM4411(E)	50mm Solvent, G2A Screwthread	150

Inlet Fittings

RETURN INLET & WALL RETURN

Return Inlet (EM4414)

1. For vinyl pool
2. Recommended wall conduit EM2842
3. Adjustable angle

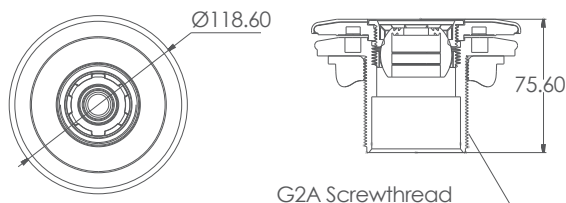

Code	Model	Connection	Brass Inserts	Flow Rate (L/min)
91601223	EM4414(A)	1.5" Solvent, G2A Screwthread	Yes	150
91601224	EM4414(E)	50mm Solvent, G2A Screwthread	Yes	150
91601229	EM4414A TS	1.5" Solvent, G2A Screwthread	No	150
91601230	EM4414E TS	50mm Solvent, G2A Screwthread	No	150

Return Inlet (EM4415)

1. For concrete & fibreglass pools
2. Recommended wall conduit EM2842
3. Adjustable angle

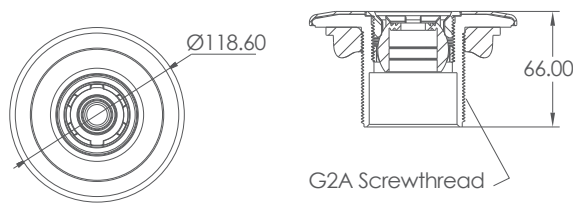

Code	Model	Connection	Flow Rate (L/min)
91601225	EM4415(A)	1.5" Solvent, G2A Screwthread	150
91601226	EM4415(E)	50mm Solvent, G2A Screwthread	150

WALL RETURN

Wall Return (EM2824)

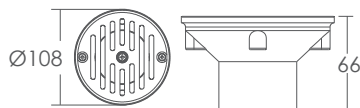

Code	Model	Connection	Measure	Flow Rate (L/min)
91600806	EM2824(A1)	1.25" Solvent	Imperial	92
91600807	EM2824(A2)	1.5" Solvent	Imperial	150
91600808	EM2824(A3)	2" Solvent	Imperial	240
91600809	EM2824(E1)	50mm Solvent	Metric	150
91600810	EM2824(E2)	63mm Solvent	Metric	240
91600828	EM2824(A4)	1.5"/2" Class 12	Imperial	240

Wall Return (EM2825)

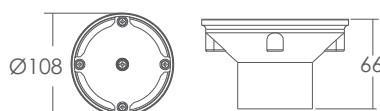

Code	Model	Connection	Measure	Flow Rate (L/min)
91600811	EM2825(A1)	1.25" Solvent	Imperial	92
91600813	EM2825(A2)	1.5" Solvent	Imperial	150
91600812	EM2825(A3)	2" Solvent	Imperial	240
91600814	EM2825(E1)	50mm Solvent	Metric	150
91600815	EM2825(E2)	63mm Solvent	Metric	240
91600829	EM2825(A4)	1.5"/2" Class 12	Imperial	240

Wall Return (EM2826)

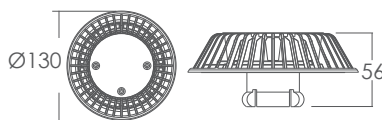

Code	Model	Connection	Measure	Flow Rate (L/min)
91600816	EM2826(A1)	1.5" Class 12	Imperial	122
91600817	EM2826(A2)	2" Class 12	Imperial	200
91600818	EM2826(E1)	50mm PN10	Metric	150

Inlet Fittings

FLOOR INLET, SPA JET, EYEBALL JET AND JET BODY

FLOOR INLET

Floor Inlet (EM2817)

Safety Suction Cover

Comply with Australian standard: AS 1926.3-2012

1.5" test no.: 8180009

2" test no.: 817024.2

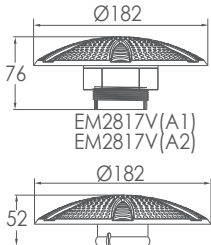

EM2817C(A1) / EM2817C(A2)
EM2817C(E1) / EM2817C(E2)

Code	Model	Connection	Application	Flow Rate (L/min)
91600520	EM2817V(A1)	1.5" Solvent	Vinyl Pool	328
91600521	EM2817V(A2)	2.0" Solvent	Vinyl Pool	328
91600518	EM2817C(A1)	1.5" Class 12	Concrete Pool	328
91600519	EM2817C(A2)	2.0" Class 9	Concrete Pool	328
91600526	EM2817C(A3)	1.5" Class 15	Concrete Pool	328
91600527	EM2817C(A4)	2.0" Class 15	Concrete Pool	328
91600530	EM2817C(A5)	1.5" Class 9	Concrete Pool	328
91600531	EM2817C(A6)	2.0" Class 12	Concrete Pool	328
91600524	EM2817C(E1)	50mm PN10	Concrete Pool	328
91600525	EM2817C(E2)	63mm PN10	Concrete Pool	328
91600528	EM2817C(E3)	50mm PN16	Concrete Pool	328
91600529	EM2817C(E4)	63mm PN16	Concrete Pool	328

Floor Inlet (EM2864(E))

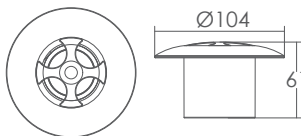

Code	Model	Connection	Application	Flow Rate (L/min)
91600825	EM2864(E)	50mm/63mm PN10 Solvent	Concrete Pool	150/240

Floor Inlet (EM2861)

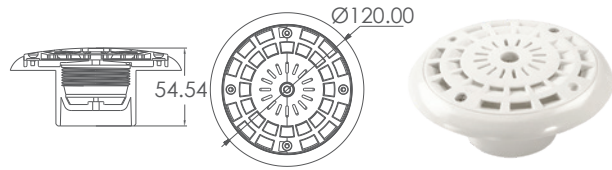

Code	Model	Connection	Application	Flow Rate (L/min)
91600819	EM2861(A)	2" Class 12 Solvent	Concrete Pool	200
91600826	EM2861(A1)	2" Class 15 Solvent	Concrete Pool	200
91600820	EM2861(E)	63mm PN10 Solvent	Concrete Pool	200
91600827	EM2861(E1)	63mm PN16 Solvent	Concrete Pool	200

Floor Inlet (EM2862)

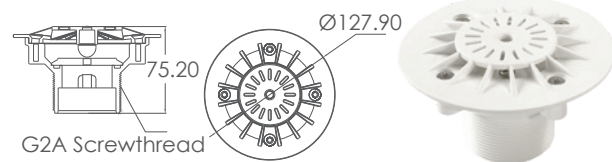

Code	Model	Connection	Application	Flow Rate (L/min)
91600821	EM2862(A)	1.5" Solvent, G2A Screwthread	Concrete Pool	200
91600822	EM2862(E)	GB50 Solvent, G2A Screwthread	Concrete Pool	200

Floor Inlet (EM2863)

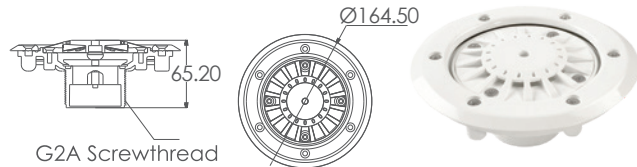

Code	Model	Connection	Application	Flow Rate (L/min)
91600823	EM2863(A)	1.5" Solvent, G2A Screwthread	Vinyl Pool	200
91600824	EM2863(E)	GB50 Solvent, G2A Screwthread	Vinyl Pool	200

SPA JET, EYEBALL JET AND JET BODY

φ10mm Barb Air & φ20mm Barb Water, Ell Body

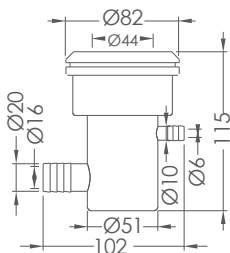

Code	Model	Flow Rate (L/min)
91601301	EM0021	53

φ32mm Air & φ50mm Water, Tee Body

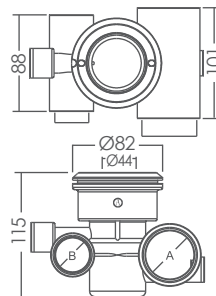

Code	Model	A	B	Flow Rate (L/min)
91601302	EM0031(A)	1.5"	1"	76
91601303	EM0031(E)	50mm	32mm	76

Inlet Fittings

SPA JET, EYEBALL JET AND JET BODY

Eyeball Standard Jet

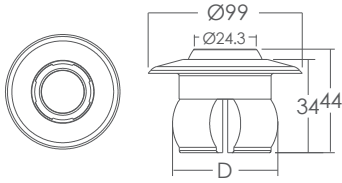

Code	Model	D	Flow Rate (L/min)
91601205	EM3301(A1)	1.5" Class 12	69
91601206	EM3301(A2)	2" Class 12	69
91601207	EM3301(E1)	50mm PN10	69
91601240	EM3301(E2)	50mm PN16	69

Eyeball Jet

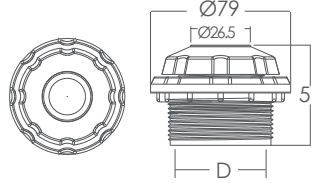

Code	Model	D	Flow Rate (L/min)
91601208	EM3302(A)	1.5"	69
91601209	EM3302(E)	50mm	69

Eyeball Jet

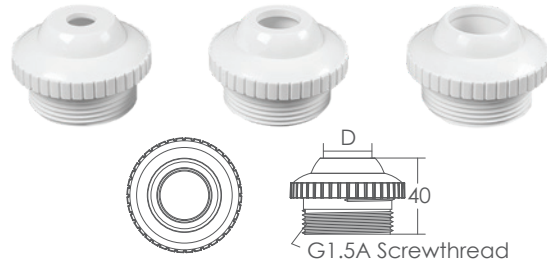
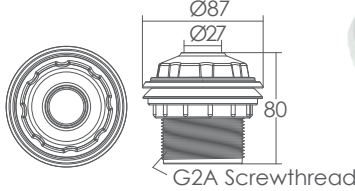

Code	Model	Connection	Flow Rate (L/min)
91601244	EM4420(A)	1.5" Solvent G2A Screwthread	240
91601245	EM4420(E)	50mm Solvent G2A Screwthread	240

Code	Model	D	Flow Rate (L/min)
91601249	EM4421 1"	1"	350
91601248	EM4421 3/4"	3/4"	200
91601247	EM4421 1/2"	1/2"	90

Concrete Spa Jet (1.5" 50mm air & water)

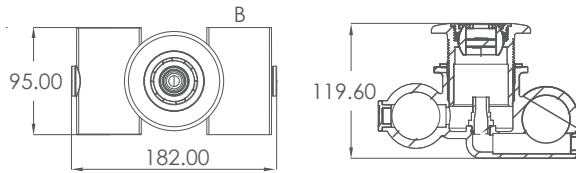

Code	Model	B	Flow Rate (L/min)
91601241	EM4419(A)	1.5"	50
91601242	EM4419(E)	50mm	50

Swirl Jet

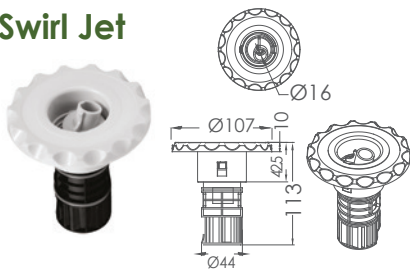

Code	Model	Flow Rate (L/min)
91601401	EM0018	17

Swirl Jet



Code	Model	Flow Rate (L/min)
91601402	EM0028	17

Standard Jet



Code	Model	Flow Rate (L/min)
91601403	EM0034	17

Smooth Face Standard Jet

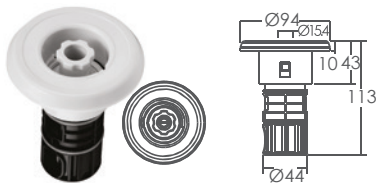

Code	Model	Flow Rate (L/min)
91601404	EM0044	17

Smooth Face Swirl Jet

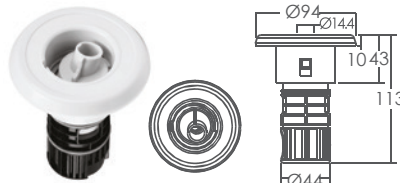

Code	Model	Flow Rate (L/min)
91601405	EM0048	17

Standard Jet

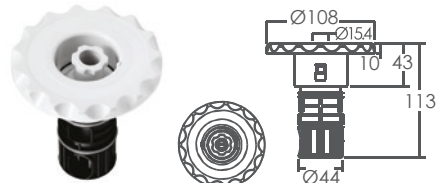

Code	Model	Flow Rate (L/min)
91601406	EM0064	17

Spa Fittings

1.5" Spa Venturi

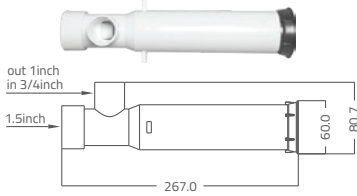

Code	Model No.	Material
93001901	EM2501	PVC

L-Type Jet Body

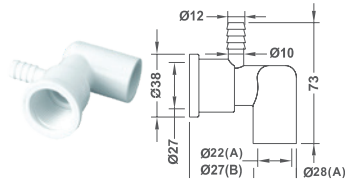

Code	Model No.	Material
91500505	EM2201A	PVC
91500506	EM2201B	PVC

L-Type Jet Body

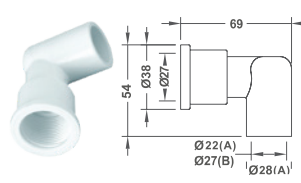

Code	Model No.	Material
91500507	EM2202A	PVC
91500508	EM2202B	PVC

L-Type Jet Body

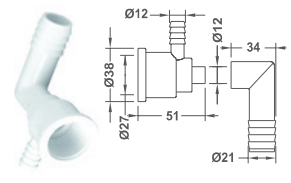

Code	Model No.	Material
91500509	EM2203	PVC

L-Type Jet Body

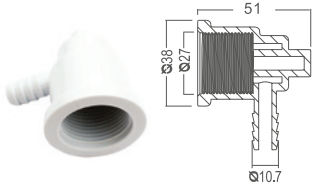

Code	Model No.	Material
91500510	EM2204	PVC

Single Hole Air Jet

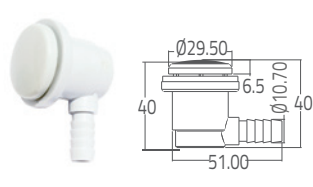

Code	Model No.	Material
91500902	EM1159	PVC

Twin Hole Air Jet

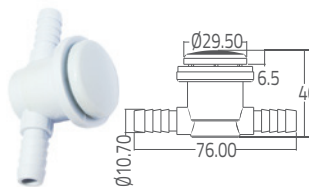

Code	Model No.	Material
91500901	EM1160	PVC

Tiny Air Jet

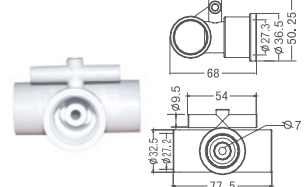

Code	Model No.	Material
91500504	EM1158	PVC

I Type Jet



Code	Model No.	Material
91500401	EM1144	ABS&PVC

φ2" Face (Standard) Jet

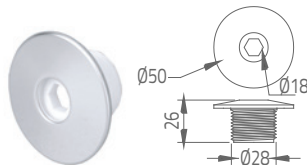

Code	Model No.	Material	Flow Rate m ³ /h	1pm
91500604	EM2207	ABS	0.5	8.4

φ1-1/2" Face (Standard) Jet

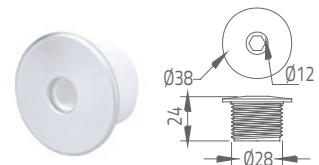

Code	Model No.	Material	Flow Rate m ³ /h	1pm
91500605	EM2208	ABS	0.3	5.3

φ1-1/2" Face (Radial) Jet



Code	Model No.	Material	Flow Rate m ³ /h	1pm
91500606	EM2209	PVC	0.1	1.8

φ2" Face (Spiral) Jet

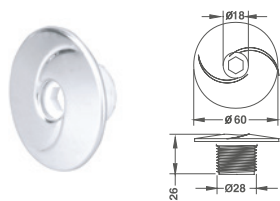

Code	Model No.	Material	Flow Rate m ³ /h	1pm
91500607	EM2210	PVC	0.5	8.4

Nine Hole Jet



Code	Model No.	Material	Flow Rate m ³ /h	1pm
91500608	EM2211	ABS	0.3	5.7

φ2-3/4" Face Eyeball Spa Jet

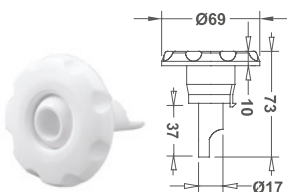

Code	Model No.	Material	Flow Rate m ³ /h	1pm
91500601	EM1113	PVC	1.0	16.5



Single Hole Jet

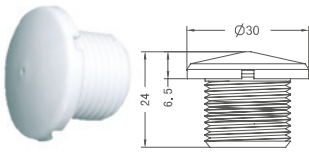

Code	Model No.	Material
91500609	EM2212	ABS&PVC

φ2-3/4" Vortex Face Eyeball Spa Jet

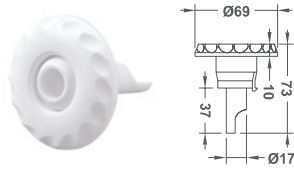

Code	Model No.	Material
91601407	EM1123	PVC

φ25mm Barb Air & φ25mm Water Tee Body

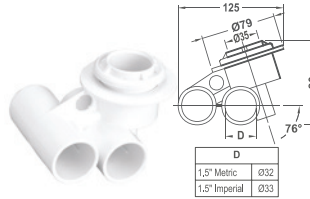

Code	Model No.	Material
91500501	EM1138	PVC
91500502	EM1138E	PVC

φ10mm Barb Air & φ25mm Water

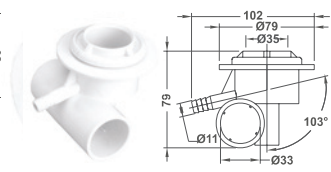

Code	Model No.	Material
91500503	EM1148	PVC

φ25mm Air Control

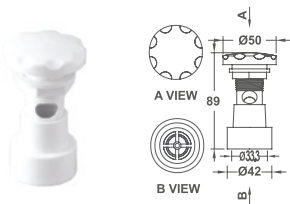

Code	Model No.	Material
91500801	EM1834	ABS

Standard Air Control

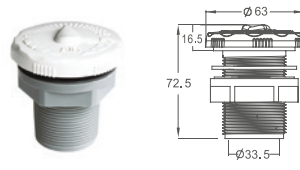

Code	Model No.	Material
91500802	EM1835	ABS

Air Button

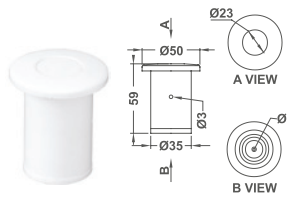

Code	Model No.	Material
91500701	EM1844	ABS

Air Button

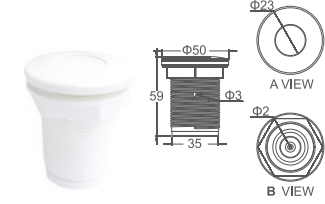

Code	Model No.	Material
91500702	EM1845	ABS

φ2 Section Drain Ell Body(Threaded)

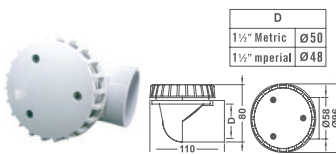

Code	Model No.	Material
91500303	EM3822A(A)	ABS&PVC
91500304	EM3822A(E)	ABS&PVC

φ2 Section Drain Ell Body(Slip Fit)

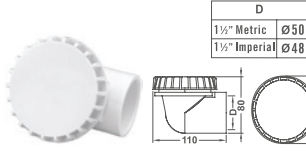

Code	Model No.	Material
91500305	EM3822B(A)	ABS&PVC
91500306	EM3822B(E)	ABS&PVC

φ2 Section Drain Straight Body(with Bolt)

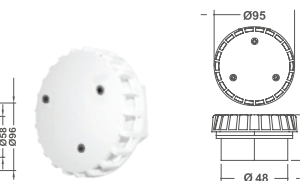

Code	Model No.	Material
91500308	EM3833A	ABS&PVC

φ2 Section Drain Straight Body

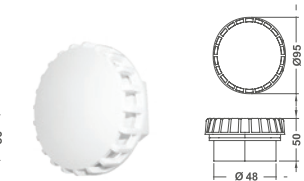

Code	Model No.	Material
91500309	EM3833B	ABS&PVC

Swirl Type Water Return

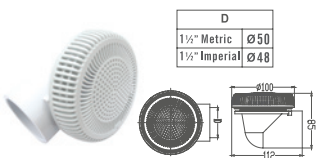

Code	Model No.	Material
91500310	EM3844A	ABS&PVC
91500311	EM3844E	ABS&PVC

Water Return

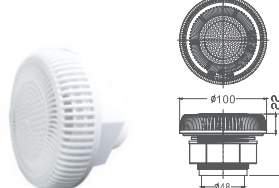

Code	Model No.	Material
91500307	EM3845	ABS&PVC

φ2 Section Drain Lock Nut



Code	Model No.	Color	Material
91500301	EM3811A	White/Grey	ABS&PVC
91500302	EM3811E	White/Grey	ABS&PVC

Port Air Manifold

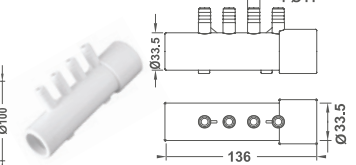

Code	Model No.	Material
91500002	EM1825	ABS

Port Water Barb Manifold

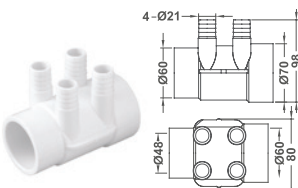

Code	Model No.	Material
91500001	EM1824	ABS

Barb Plug

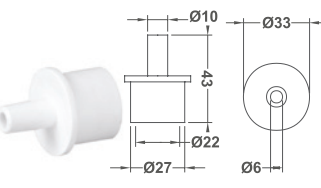

Code	Model No.	Material
91500202	EM1816	PVC

Pipe Plug

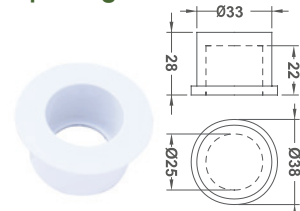

Code	Model No.	Material
91500102	EM1818B	PVC

Pipe Plug

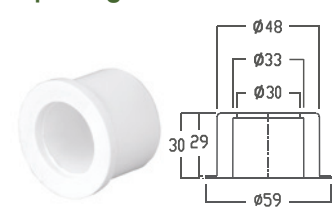

Code	Model No.	Material
91500101	EM1818A	PVC

Outlet Fittings **HEAVY DUTY SKIMMER**

Corrosion-Proof Unibody Construction

The heavy-duty skimmer can be used for residential and commercial swimming pools suitable for concrete, fiberglass and vinyl surfaces. The 3 models are injection molded and made with UV resistant ABS material; the reinforced material provides the maximum strength and durability for all weather conditions. The design allows 1.5" or 2" suction connections to the piping.

Product Features

1. Suitable for 1.5" and 2" piping
2. Knockout overflow / fill port
3. A large debris collection basket
4. Snap-in and removable weir
5. Optional accessories:
 - a) Stackable extension collar allows infinite vertical height
 - b) Stackable extension throat allows infinite horizontal length

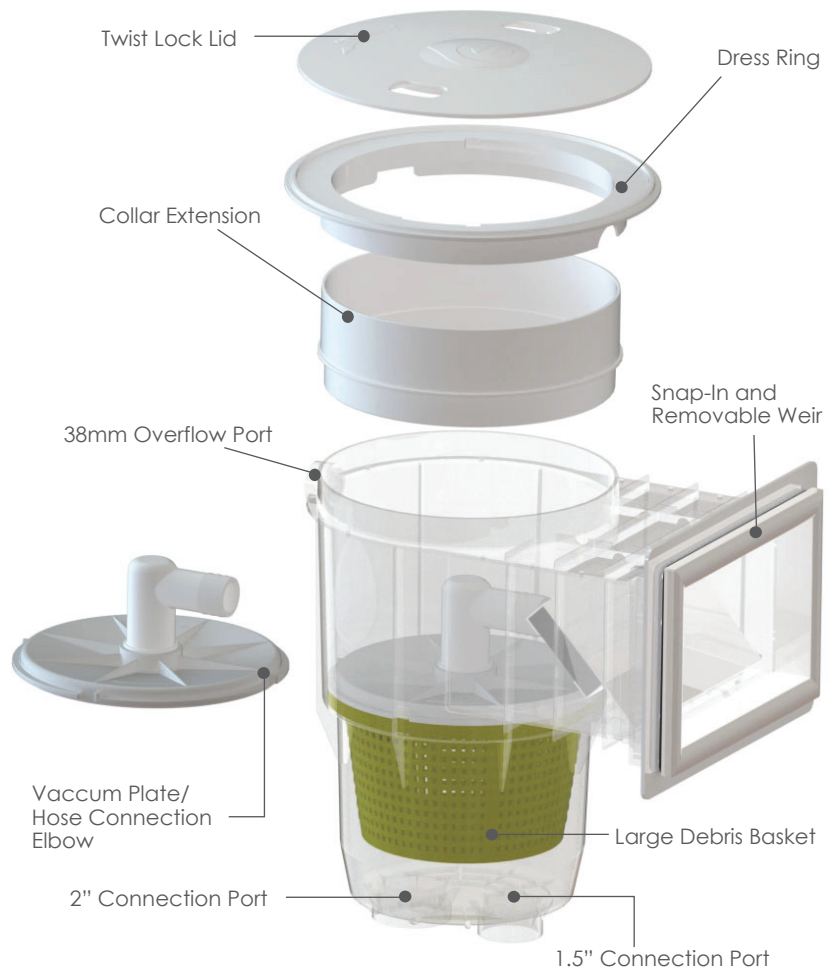

Standard Wall Heavy Duty Skimmer (EM0030)

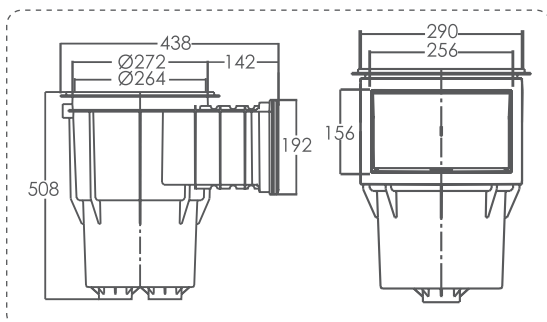

EM0030RV EM0030RC



EM0030SV EM0030SC

Code	Model	Application	Flow Rate (L/min)
91600305	EM0030-RV	Vinyl Pool (Round Cover)	150 - 200
91600303	EM0030-RC	Concrete Pool (Round Cover)	150 - 200
91600309	EM0030-SV	Vinyl Pool (Square Cover)	150 - 200
91600307	EM0030-SC	Concrete Pool (Square Cover)	150 - 200

Wide Mouth Wall Heavy Duty Skimmer (EM0040)

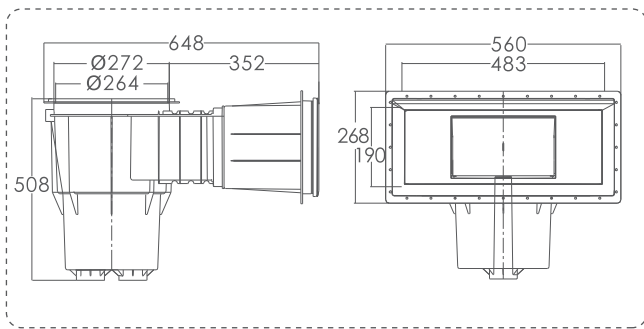

EM0040RV EM0040RC

EM0040SV EM0040SC

Code	Model	Application	Flow Rate (L/min)
91601005	EM0040-RV	Vinyl Pool (Round Cover)	150 - 200
91601003	EM0040-RC	Concrete Pool (Round Cover)	150 - 200
91601009	EM0040-SV	Vinyl Pool (Square Cover)	150 - 200
91601007	EM0040-SC	Concrete Pool (Square Cover)	150 - 200

Heavy Duty Skimmer With Extension (EM0050)

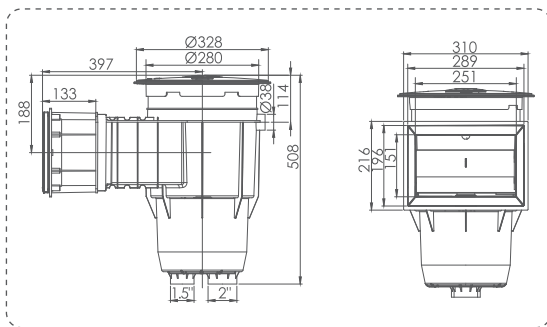

EM0050RV EM0050RC

EM0050SV EM0050SC

Code	Model	Application	Flow Rate (L/min)
91600903	EM0050-RV	Vinyl Pool (Round Cover)	150 - 200
91600901	EM0050-RC	Concrete Pool (Round Cover)	150 - 200
91600907	EM0050-SV	Vinyl Pool (Square Cover)	150 - 200
91600905	EM0050-SC	Concrete Pool (Square Cover)	150 - 200

Heavy Duty Skimmer Accessories



Wide Mouth Extension
Code: 11503031



Extension Throat
(wide) Code: 01050023
(narrow) Code: 11503042



Extension Collar
Code: 11503044



Basket with Plastic Handle
Code: 41202170



Square Dress Ring
Code: 11503012



Round Dress Ring
Code: 11503027



Skimmer Cover
Code: 41202031



Vacuum Plate
Code: 12431002



90° Vacuum Hose Connector
Code: 12403042

Outlet Fittings SKIMMER

9.5L Wall Skimmer (EM0010)

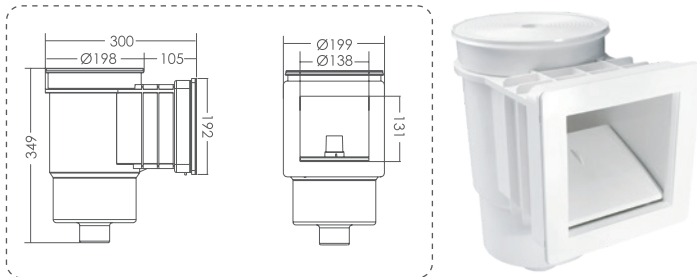

Code	Model	Connection	Application	Flow Rate (L/min)
91600302	EM0010-RV	1.5" Internal Threaded	Vinyl Pool	150
91600301	EM0010-RC	1.5" Internal Threaded	Concrete Pool	150

9.5L Wide Mouth Wall Skimmer (EM0020)

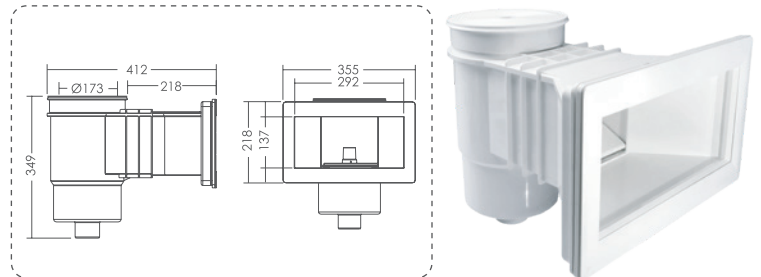

Code	Model	Connection	Application	Flow Rate (L/min)
91601002	EM0020-RV	1.5" Internal Threaded	Vinyl Pool	150
91601001	EM0020-RC	1.5" Internal Threaded	Concrete Pool	150
91601015	EM0020T-RV	1.5" Internal Threaded	Vinyl Pool (with brass inserts)	150

15L Standard Wall Skimmer (EM0130)

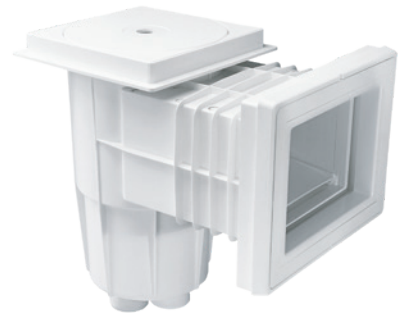
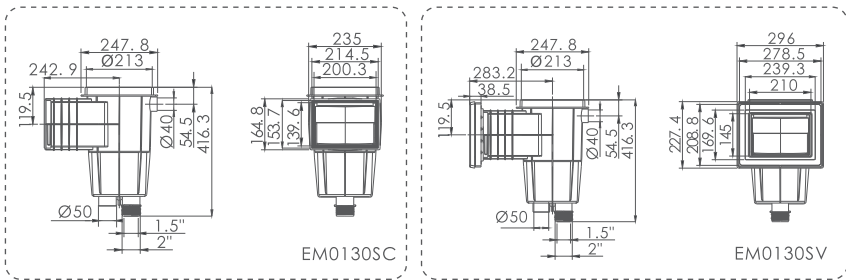

EM0130SC EM0130SV

Code	Model	Connection	Application	Flow Rate (L/min)
91600315	EM0130-SC	1.5" and 2" Internal Threaded and 1.5" Solvent Internal	Concrete Pool	150 - 200
91600316	EM0130-SV	1.5" and 2" Internal Threaded and 1.5" Solvent Internal	Vinyl Pool	150 - 200
91600320	EM0130TS-SV	1.5" and 2" Internal Threaded and 1.5" Solvent Internal	Vinyl Pool (without brass inserts)	150 - 200

15L Wide Mouth Wall Skimmer (EM0140)

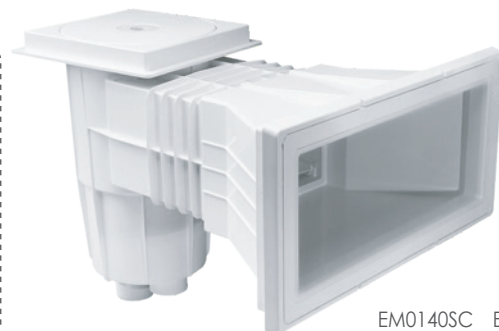
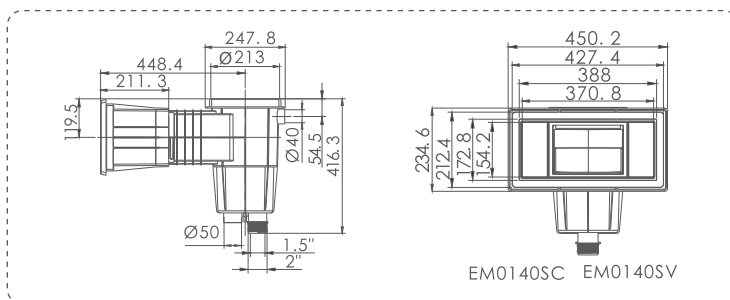

EM0140SC EM0140SV

Code	Model	Connection	Application	Flow Rate (L/min)
91601013	EM0140-SC	1.5" and 2" Internal Threaded and 1.5" Solvent Internal	Concrete Pool	150 - 200
91601014	EM0140-SV	1.5" and 2" Internal Threaded and 1.5" Solvent Internal	Vinyl Pool	150 - 200
91601016	EM0140TS-SC	1.5" and 2" Internal Threaded and 1.5" Solvent Internal	Concrete Pool (without brass inserts)	150 - 200
91601017	EM0140TS-SV	1.5" and 2" Internal Threaded and 1.5" Solvent Internal	Vinyl Pool (without brass inserts)	150 - 200

Outlet Fittings

SURFACE SKIMMER, SUCTION AND VACUUM

SURFACE SKIMMER

Elegant & Functional This 600mm wide surface skimmer enables the water line to be close to the pool deck level and creates an elegant finish similar to an overflow pool. A wide skimmer mouth and a large basket maximize water circulation and skimming efficiency.

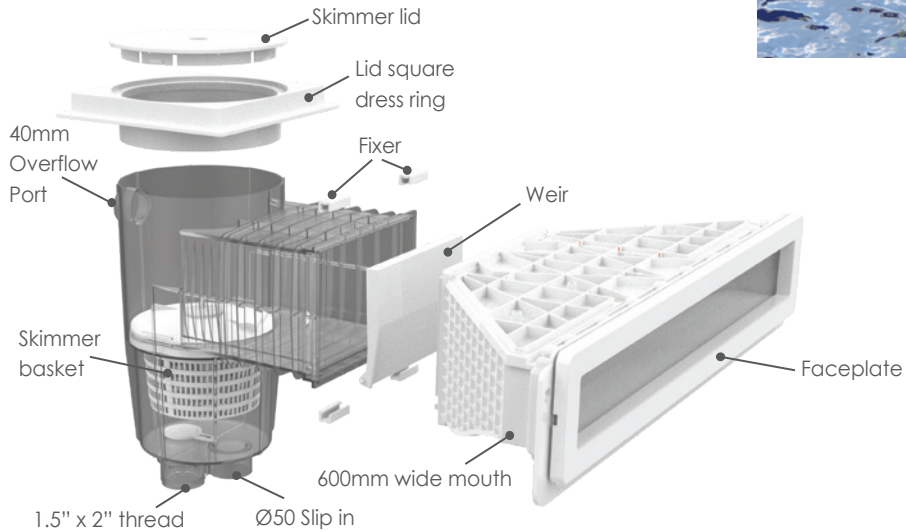
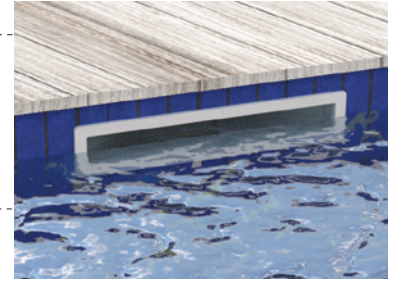

15L Surface Wall Skimmer (EM0180)

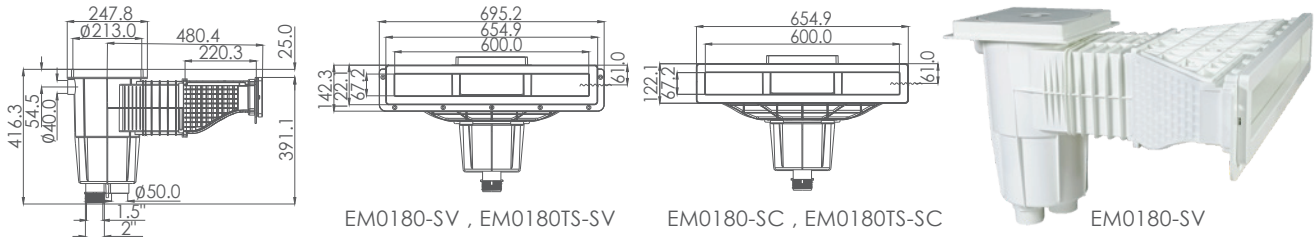

Code	Model	Connection	Application	Flow Rate (L/min)
91601022	EM0180-SC	1.5" and 2" Internal Threaded and 1.5" Solvent Internal	Concrete Pool	150 - 200
91601023	EM0180-SV	1.5" and 2" Internal Threaded and 1.5" Solvent Internal	Vinyl Pool	150 - 200
91601024	EM0180TS-SC	1.5" and 2" Internal Threaded and 1.5" Solvent Internal	Concrete Pool (without brass inserts)	150 - 200
91601025	EM0180TS-SV	1.5" and 2" Internal Threaded and 1.5" Solvent Internal	Vinyl Pool (without brass inserts)	150 - 200

SUCTION AND VACUUM

Suction Fitting

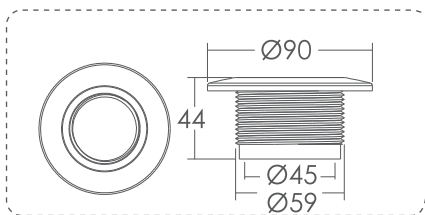

Code	Model	Flow Rate (L/min)
91601501	EM2822	150

Cover of Suction Fittings

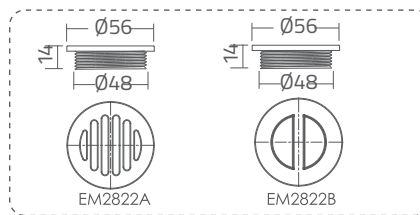

Code	Model	Flow Rate (L/min)
91601502	EM2822A	115
91601503	EM2822B	Nil

Vacuum Fitting (EM2827C) (Concrete Pool)

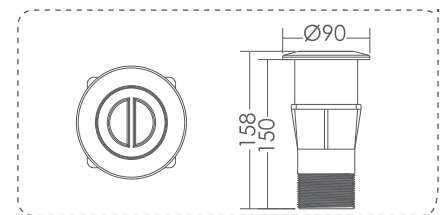

Code	Model	Connection	Measure	Flow Rate (L/min)
91601504	EM2827C(A)	1.5"	Imperial	150
91601506	EM2827C(E)	50mm	Metric	150

Outlet Fittings

SUCTION AND VACUUM

Vacuum Fitting (EM2827V)
(Vinyl Pool)



Outlet Fitting (EM2828C)
(Concrete Pool)



Outlet Fitting (EM2828V)
(Vinyl Pool)

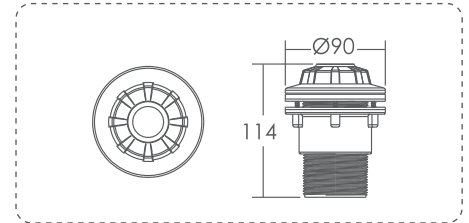
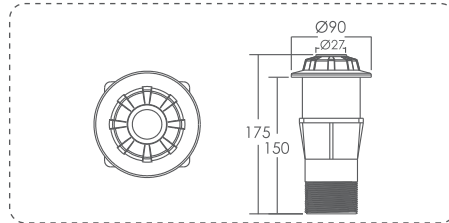
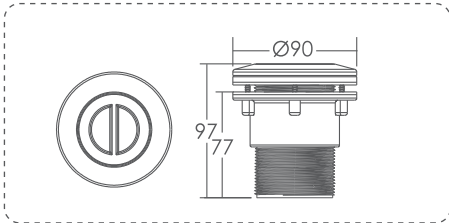

Code	Model	Connection	Measure	Flow Rate (L/min)
91601505	EM2827V(A)	1.5"	Imperial	150
91601507	EM2827V(E)	50mm	Metric	150

Code	Model	Connection	Measure	Flow Rate (L/min)
91601201	EM2828C(A)	1.5"	Imperial	69
91601203	EM2828C(E)	50mm	Metric	69

Code	Model	Connection	Measure	Flow Rate (L/min)
91601202	EM2828V(A)	1.5"	Imperial	69
91601204	EM2828V(E)	50mm	Metric	69

Vacuum Fitting (EM2831)
(Concrete Pool)



Vacuum Fitting (EM2836)
(Vinyl Pool)



Vacuum Fitting (EM2848)
(Concrete Pool)

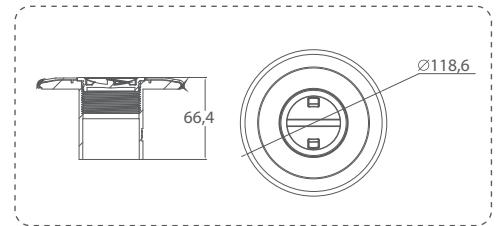
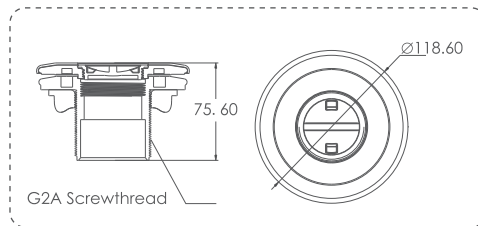
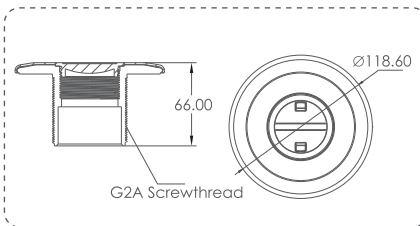

Code	Model	Connection	Flow Rate (L/min)
91601508	EM2831(A)	1.5" Solvent, G2A Screwthread	150-240
91601509	EM2831(E)	50mm Solvent, G2A Screwthread	150-240

Code	Model	Connection	Brass Inserts	Flow Rate (L/min)
91601510	EM2836A	1.5" Solvent, G2A Screwthread	Yes	150-240
91601511	EM2836E	50mm Solvent, G2A Screwthread	Yes	150-240
91601516	EM2836A TS	1.5" Solvent, G2A Screwthread	No	150-240
91601517	EM2836E TS	50mm Solvent, G2A Screwthread	No	150-240

Code	Model	Connection	Measure	Flow Rate (L/min)
91601518	EM2848(A)	1.5" / 2" Class 12 Solvent	Imperial	150-240
91601520	EM2848(A1)	2" Class 1 5 Solvent	Imperial	150-240
91601519	EM2848(E)	50mm / 63mm PN10 Solvent	Metric	150-240
91601521	EM2848(E1)	63mm PN16 Solvent	Metric	150-240

Vacuum Fitting (EM2857E)
(Concrete Pool)



Vacuum Lock Safety Wall Fitting (EM2855)

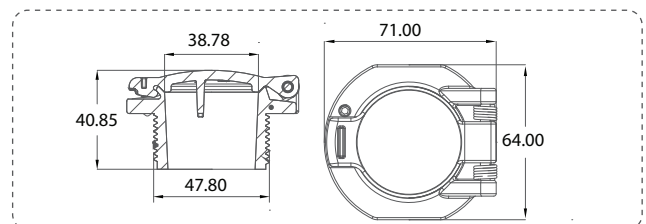
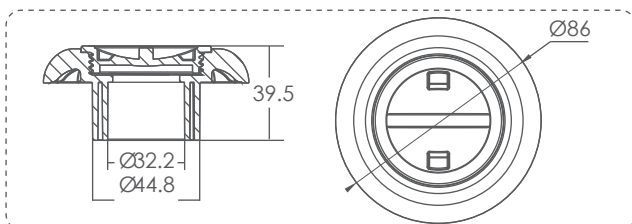

Code	Model	Connection	Flow Rate (L/min)
91601526	EM2857(E)	32mm/GB50 PN10	50-100

Code	Model	Connection	Measure	Flow Rate (L/min)
91601522	EM2855	38mm Solvent, G1.5A Screwthread	Imperial	150-240

Other Fittings

Water Level Regulator

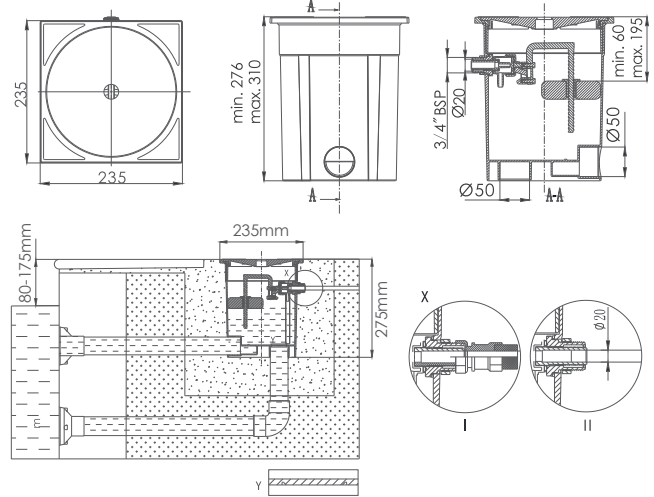
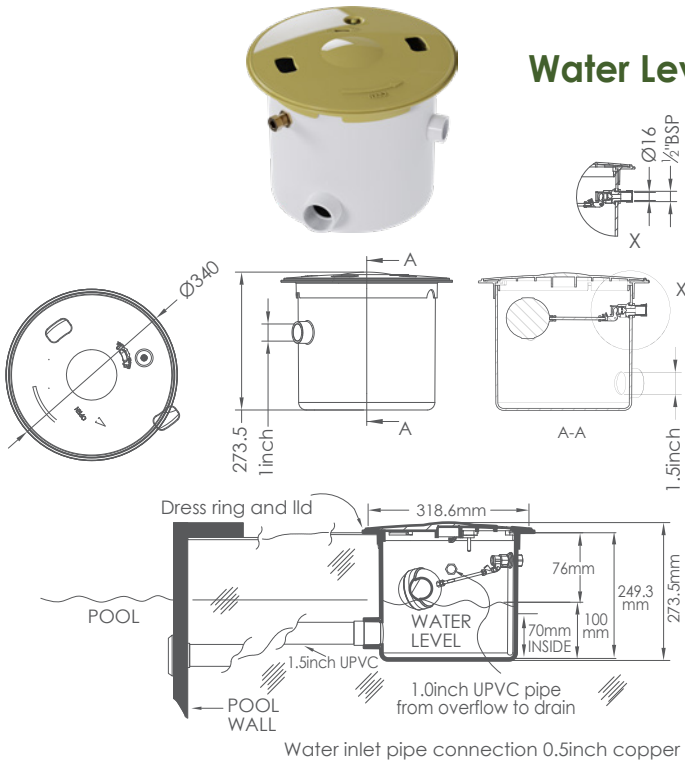

Water inlet pipe connection 0.5inch copper

Code	Model	Color	Material	Connection	Flow Rate (L/min)
91602402	RO-14	Yellow Cover & White Body	ABS	Inlet: ϕ 15mm or 1/2" BSP, Outlet: 1.5inch Drain: 1.0inch	30 - 50

Code	Model	Color	Material	Connection	Flow Rate (L/min)
91602401	RO-7	White	ABS	Inlet: ϕ 20mm or 3/4" BSP, Outlet: ϕ 50mm	30 - 50

Conduit EM2841



Conduit EM2841E

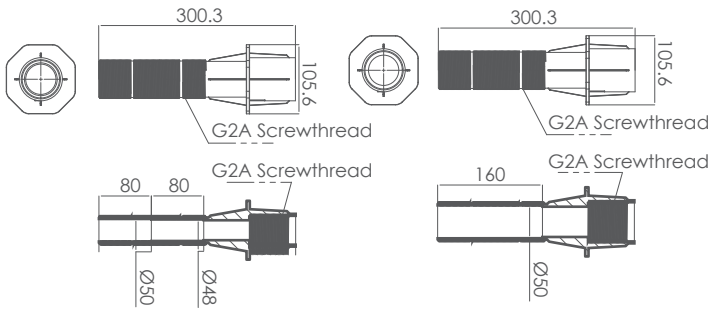

Code	Model	Connection	Application	Flow Rate (L/min)
91602501	EM2841	1.5"/50mm Solvent, G2A Screwthread	Concrete Pool	150-240
91602540	EM2841E	50mm Solvent, G2A Screwthread	Concrete Pool	150-240

Conduit EM2842



Conduit EM2842E

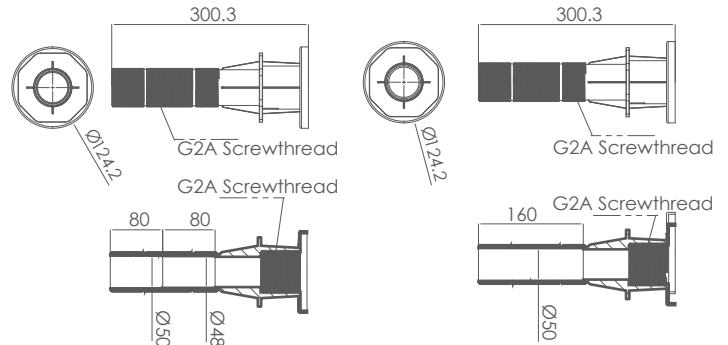

Code	Model	Connection	Application	Flow Rate (L/min)
91602502	EM2842	1.5"/50mm Solvent, G2A Screwthread	Vinyl Pool	150-240
91602541	EM2842E	50mm Solvent, G2A Screwthread	Vinyl Pool	150-240

Hydrostatic Valve for Fiberglass Pool EM2510

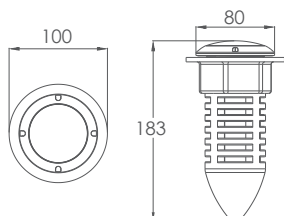

Code	Model	Description	Flow Rate (L/min)
91600401	EM2510	Hydrostatic Valve for Fiberglass Pool	150-240

Outlet Fittings MAIN DRAIN

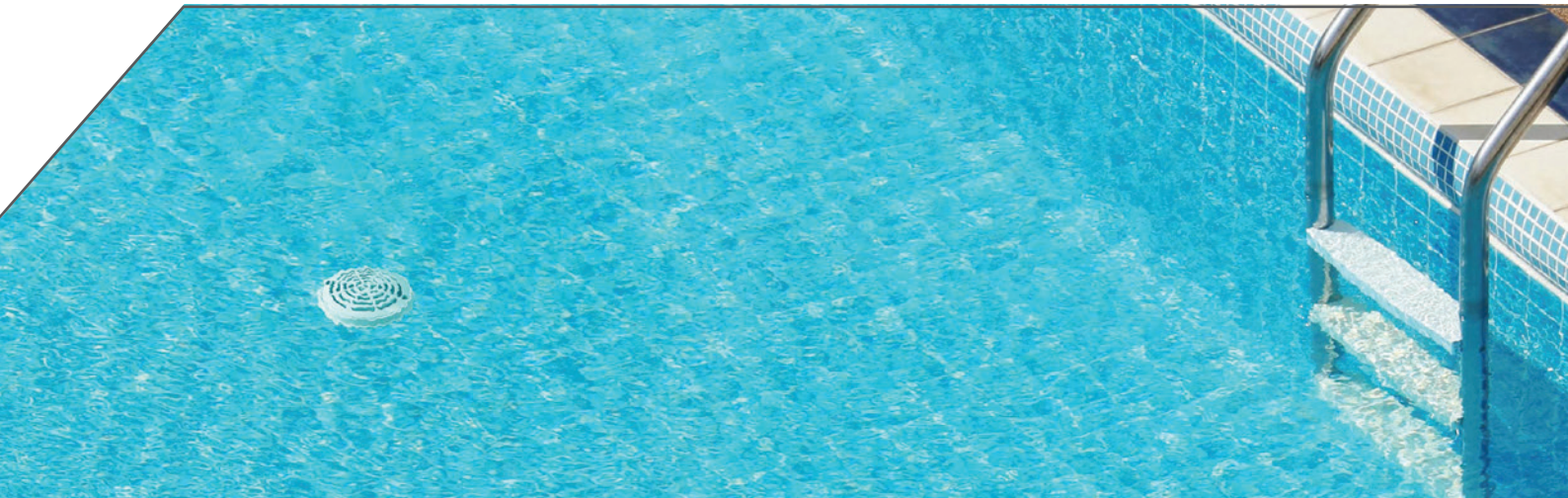

2" Main Drain (EM2833)

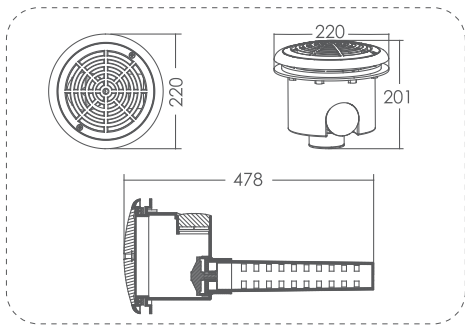

EM2833C/ EM2833V



89140501



01051155



EM2833HC

Code	Model	Connection	Description	Flow Rate (L/min)
91600504	EM2833HC	2" Internal Threaded	For Concrete Pool with Hydrostatic Relief Valve & Collection Tube	240
91600505	EM2833HV	2" Internal Threaded	For Vinyl Pool with Hydrostatic Relief Valve & Collection Tube	240
91600503	EM2833C	2" Internal Threaded	For Concrete Pool	240
91600506	EM2833V	2" Internal Threaded	For Vinyl Pool	240
91600402	--	--	Hydrostatic Relief Valve	N/A
11510001	--	--	Hydrostatic Relief Valve Collection Tube Only	N/A

1.5" Main Drain

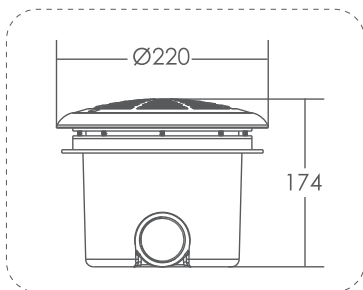

Gutter Drain

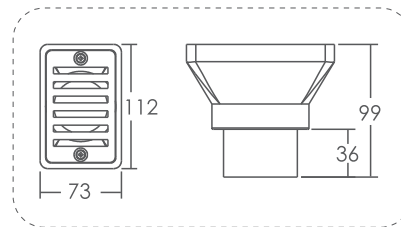

Code	Model	Connection	Application	Flow Rate (L/min)
91600507	EM2832C	1.5" Internal Threaded	Concrete Pool	150
91600508	EM2832V	1.5" Internal Threaded	Vinyl Pool	150

Code	Model	Connection	Measure	Flow Rate (L/min)
91600801	EM2819(A1)	1.25" Solvent	Imperial	92
91600802	EM2819(A2)	1.5" Solvent	Imperial	150
91600803	EM2819(A3)	2" Solvent	Imperial	240
91600804	EM2819(E1)	50mm Solvent	Metric	150
91600805	EM2819(E2)	63mm Solvent	Metric	240

Round Drain Cover (EM2830)

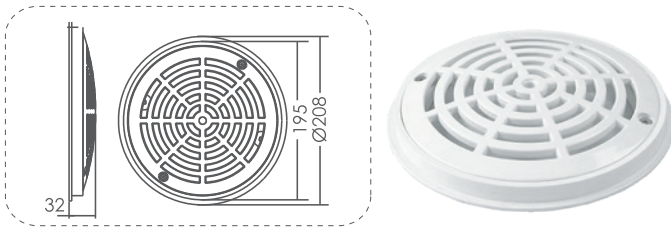

Code	Model	Size	Flow Rate (L/min)
91600502	EM2830	195mm Diameters	558

Square Drain Cover (EM2812)

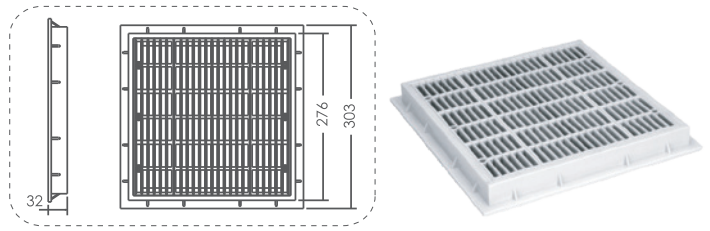

Code	Model	Size	Flow Rate (L/min)
91600501	EM2812	276 x 276 mm	850

Main Drain EM2837



Main Drain EM2838

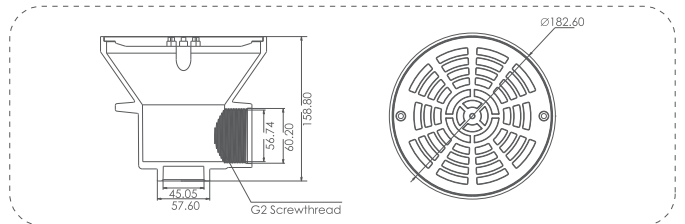
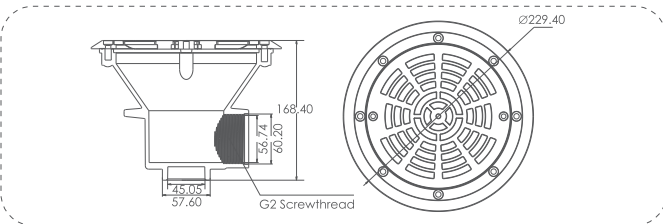

Code	Model	Connection	Application	Flow Rate (L/min)
91600514	EM2837	G2A Internal Threaded	Vinyl and Liner Pool	217
91600523	EM2837 TS	G2A Internal Threaded	Vinyl and Liner Pool (without brass inserts)	217

Code	Model	Connection	Application	Flow Rate (L/min)
91600515	EM2838	G2A Internal Threaded	Concrete Pool	217

Main Drain EM2839



Main Drain EM2840

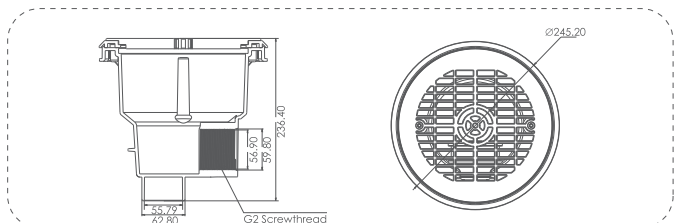
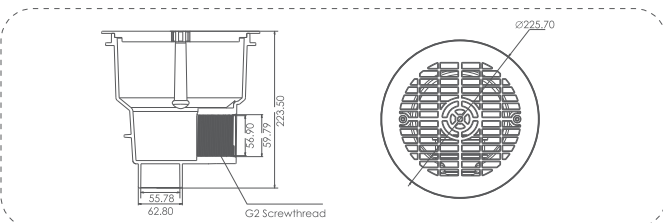

Code	Model	Connection	Application	Flow Rate (L/min)
91600516	EM2839	G2A Internal Threaded	Concrete Pool	217

Code	Model	Connection	Application	Flow Rate (L/min)
91600517	EM2840	G2A Internal Threaded	Vinyl Pool	217

VGB ANTI-VORTEX MAIN DRAIN

High Quality Standard

This series of Main Drains comply with provisions of ANSI/APSP-16 2011 standard and the Virginia Graeme Baker Pool and Spa Safety Act. High quality main drains are made of chemical and UV resistant ABS.

Main Drain (EM2813)

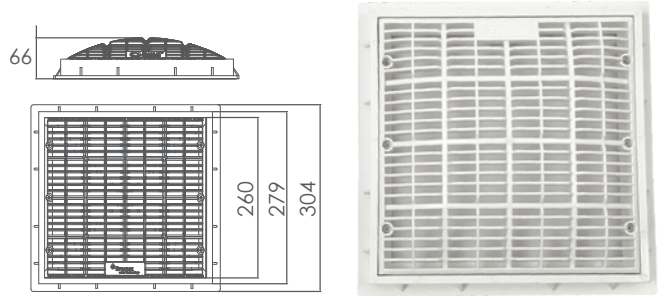

Code	Model	Size	Flow Rate (L/min)
91600509	EM2813	260 x 260mm	900

Main Drain (EM2816) (with AISI 316 Stainless Steel Frame)

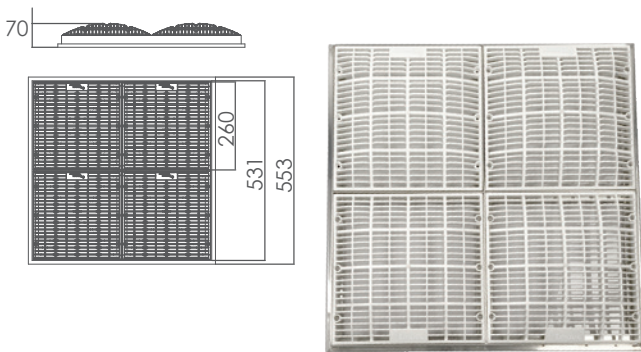

Code	Model	Size	Flow Rate (L/min)
91600510	EM2816	531 x 531mm	3600

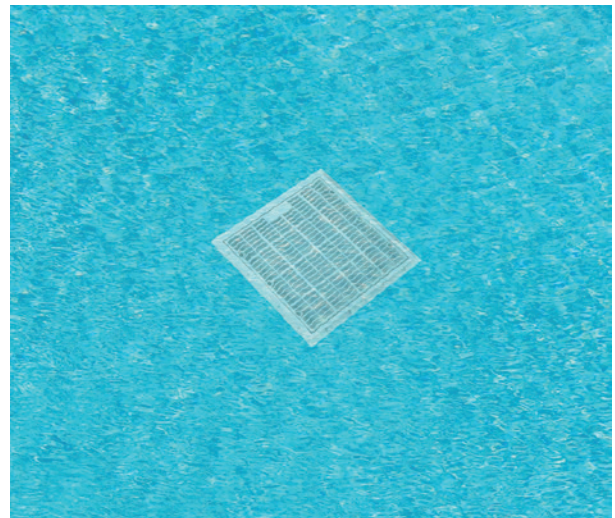

Main Drain (EM2815)

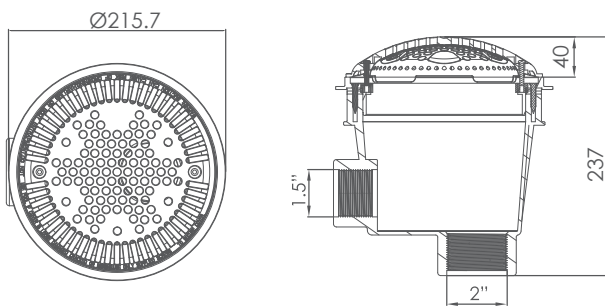

Code	Model	Connection	Application	Flow Rate (L/min)
91600511	EM2815C	1.5" / 2" Internal Threaded	Concrete Pool	240
91600512	EM2815V	1.5" / 2" Internal Threaded	Vinyl Pool	240

EMAUX WATER TECHNOLOGY CO., LTD

ADDRESS: 2/F, Lockhart Centre, No. 301-307

Lockhart Road, Wanchai, Hong Kong

PHONE +852 2832 9880

www.emauxgroup.com

YOUR PREMIER SUPPLIER

Available from: