

Pool Surrounding Equipment

DURABLE FOR ALL WEATHER CONDITIONS

Resistant to pool chemicals and sunlight



Material

ABS/ PVC

Glass Filled PP + TPV

 **Emaux**
water technology

Pool & Spa Equipment

www.emauxgroup.com

Grating System

TPV ANTISKID GRATING (DE27 Series)

Anti-slip, safe, durable and universal

This antiskid grating is designed for professional applications. The single spine grating is suitable for straight and curve overflow pools. The anti-slip coloured top offer extra comfort and maximize safety for the swimmers.

Product Features:

1. Materials : Polypropylene (PP) + Glass Filled
2. Anti-slip materials: Thermoplastic Vulcanizate (TPV)
3. Durable, UV resistant
4. Standard color : White / Blue
5. MOQ required for other colors

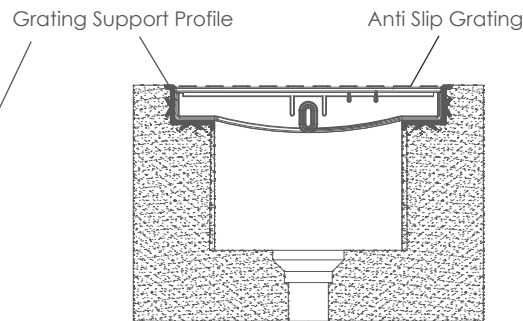
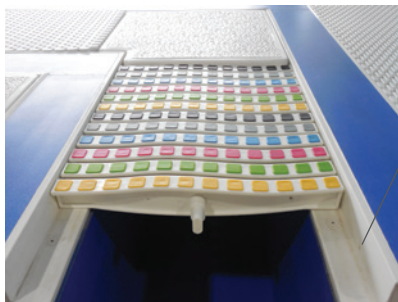

Code	Model	Color	Size
91600710	DE2720W	White	200 x 26.5 mm (1m)
91600719	DE2720B	Blue	200 x 26.5 mm (1m)
91600711	DE2725W	White	250 x 26.5 mm (1m)
91600725	DE2725B	Blue	250 x 26.5 mm (1m)
91600712	DE2730W	White	300 x 26.5 mm (1m)
91600731	DE2730B	Blue	300 x 26.5 mm (1m)

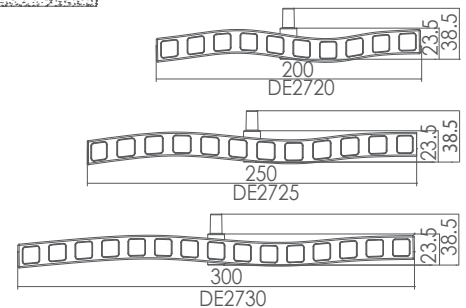
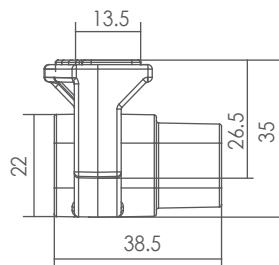

FLOOR PAD (DE30 Series)

The floor pad is made of high-strength corrosion proof PVC that resists chipping and cracking. It is portable and can be easily installed on a pool deck or changing room floor. The colourful floor pads create a soft and nonslip surface to ensure the safety of your facility.

Code	Model	Color	Size
91600601	DE3030	White	300 x 300 mm
91600602	DE3030	Red	300 x 300 mm
91600603	DE3030	Blue	300 x 300 mm
91600604	DE3030	Yellow	300 x 300 mm
91600605	DE3030	Green	300 x 300 mm

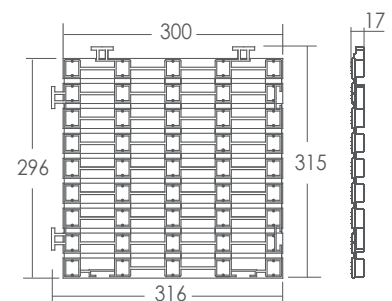
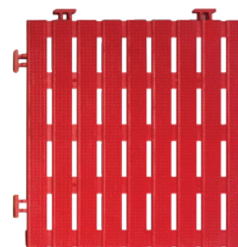

Product Features:

1. Materials : PVC
2. Standard color : White / Blue
3. Other colours available for order up to 500 metres

TRANSVERSAL PP GRATING (DE28 Series)

This transversal grating offer safety grip and minimize the gap to prevent injury. It can be used in commercial and residential pools. This sturdy and cost-effective gratings have been used in many overflow systems.

Code	Model	Size
91600713	DE2819	195 x 22 mm (1m)
91600714	DE2824	244 x 22 mm (1m)
91600715	DE2833	334 x 22 mm (1m)

Product Features:

1. Materials : Glass filled PP
2. Standard color : White
3. Other colours available for order up to 500 metres

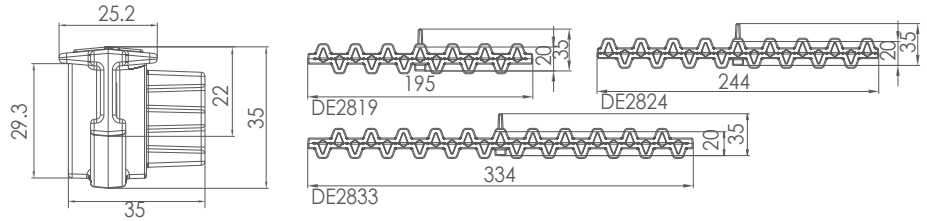

ZIGZAG TYPE GRATING (DE26 Series)

This Zigzag type grating has a heavy-duty construction that offers a long product life. The zigzag shape provides a smooth surface and solid support in both straight and curved installation.

Code	Model	Size
91600706	DE2618	180 x 30 mm (1m)
91600707	DE2620	200 x 30 mm (1m)
91600708	DE2625	250 x 30 mm (1m)
91600709	DE2630	300 x 30 mm (1m)

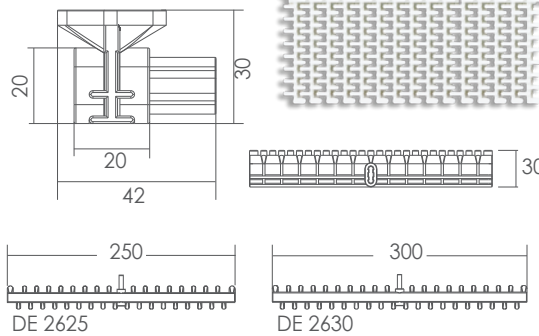
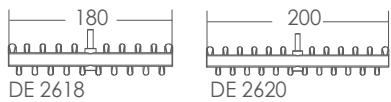

Product Features:

1. Materials : ABS
2. Standard color : White
3. Other colours available for order up to 500 metres

CURVABLE PP GRATING (DE29 Series)

This modern design curvable grating is made of PP material to achieve both sturdy and cost-effective. It has the most popular dimensions and functions to fit in your designs of different pool shapes.

Code	Model	Size
91600716	DE2919	195 x 22 mm (1m)
91600717	DE2924	244 x 22 mm (1m)
91600718	DE2929	297 x 22 mm (1m)

Product Features:

1. Materials : Glass filled PP
2. Standard color : White
3. Other colours available for order up to 500 metres

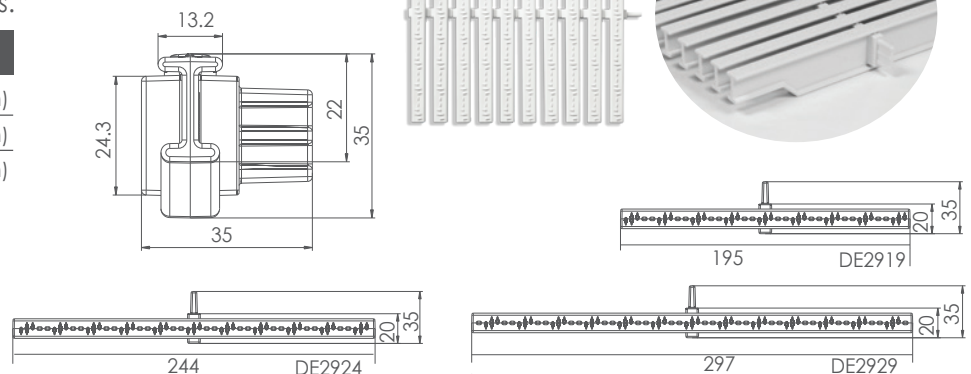

CURVABLE GRATING (DE25 Series)

This curvable grating snaps together by a single spine permitting maximum flexibility. It can be easily adapted to most free-form pool shapes. The nonslip surface and solid support increase the grating's safety and durability.

Product Features:

1. Materials : ABS
2. Standard color : White
3. Other colours available for order up to 500 metres

Code	Model	Size
91600702	DE2518	180 x 26 mm (1m)
91600703	DE2520	200 x 26 mm (1m)
91600704	DE2525	250 x 26 mm (1m)
91600705	DE2530	300 x 26 mm (1m)

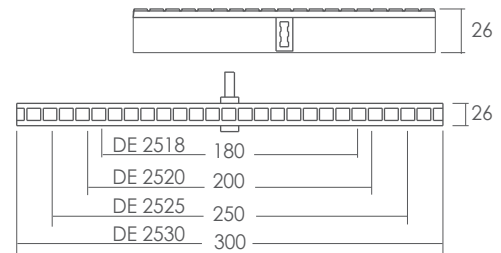
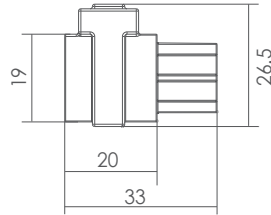
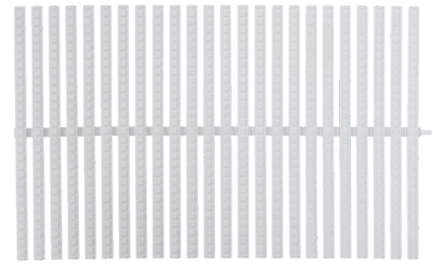

CORNER TILE AND PROFILE

90° Fiberglass Corner Tile (FT30 Series)

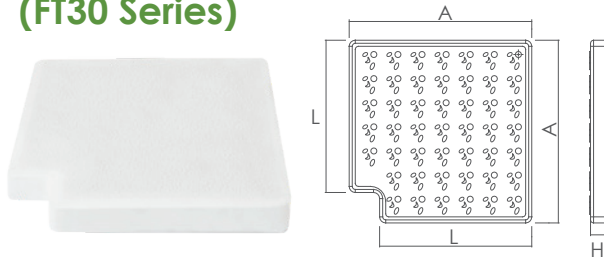

Code	Model	A mm	H mm	L mm
91601606	FT3090	350	28.5	300
91601604	FT2590	300	28.5	250
91601602	FT2090	250	28.5	200

45° Fiberglass Corner Tile (FT30 Series)

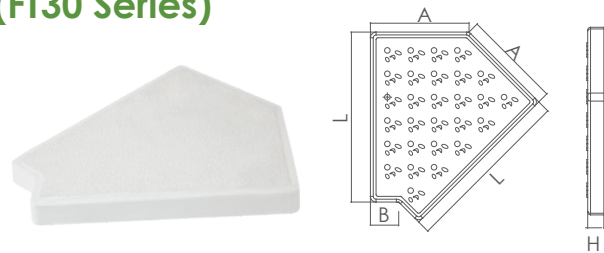

Code	Model	A mm	B mm	H mm	L mm
91601605	FT3045	174	50	28.5	300
91601603	FT2545	154	50	28.5	250
91601601	FT2045	133	50	28.5	200

Grating Support Profile

Supplied in lengths of 2 metres. Suitable for 26.5mm and 30mm high grating.

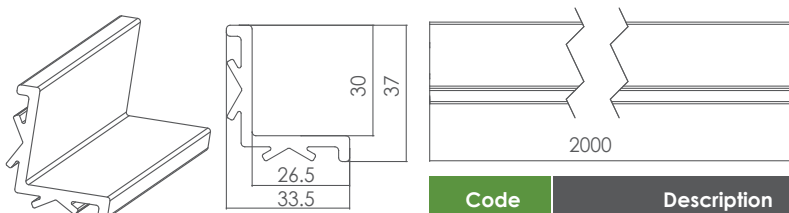

Code	Description
01150047	Grating Support Profile 2 meters



EMAUX WATER TECHNOLOGY CO., LTD

ADDRESS: 2/F, Lockhart Centre, No. 301-307
Lockhart Road, Wanchai, Hong Kong
PHONE +852 2832 9880
www.emauxgroup.com

 YOUR PREMIER SUPPLIER

Available from: